

MAY 20
1933

4-TUBE S-W A-C SET

15c
PER COPY

RADIO

REG. U.S. PAT. OFF.

WORLD

The First and Only National Radio Weekly
Twelfth Year *582d Consecutive Issue*

Official Data on
New 53 Tube

Hum Elimination
in Universal Sets

Heterodyne Oscillator

PATHFINDER 10-TUBE SUPER

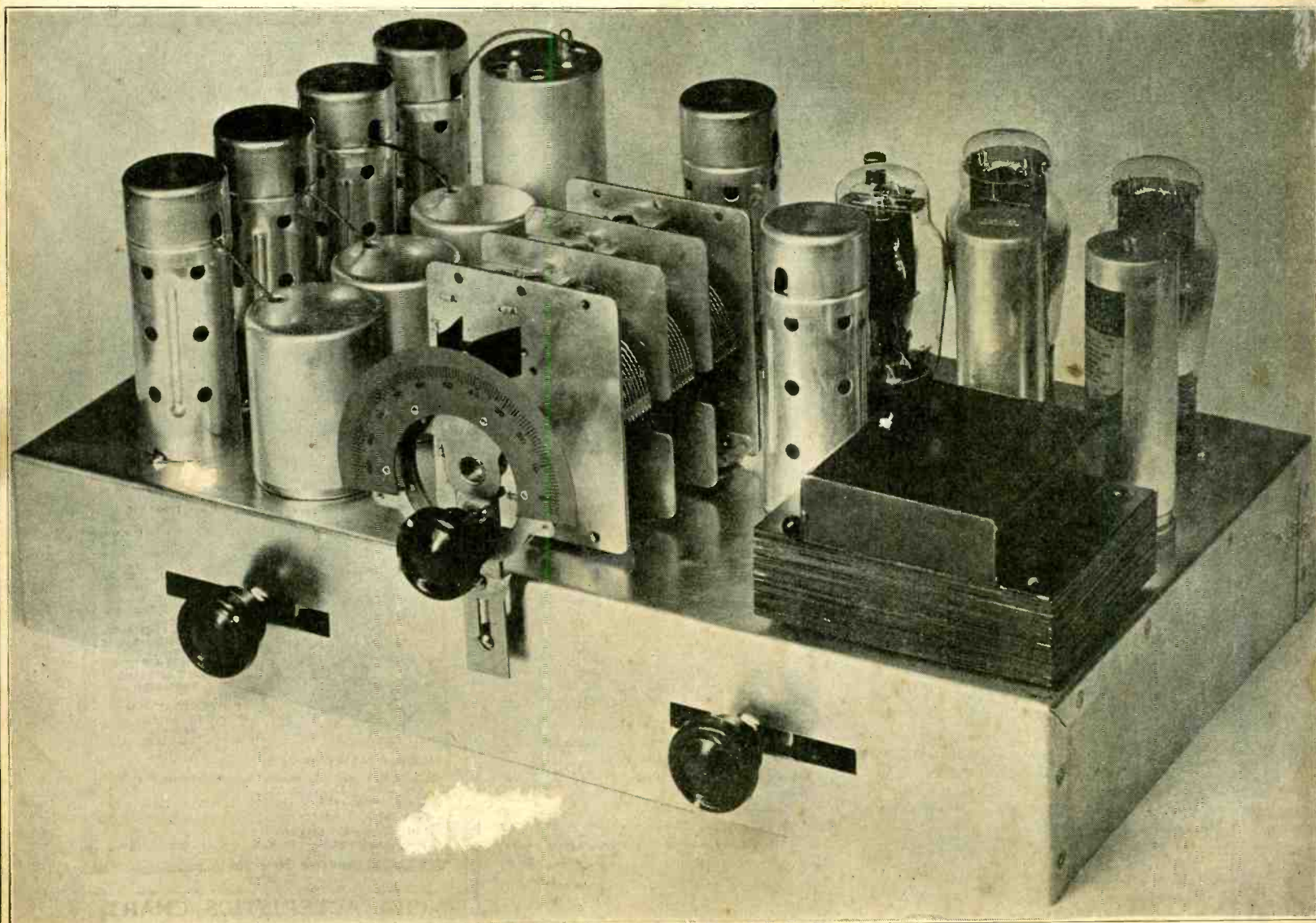

This is the layout of the 10-tube Pathfinder superheterodyne. It represents thoughtful design of a highly sensitive receiver. See pages 12 and 13.

NEW TUBE RELEASE FOR THE LATEST AND BEST IN RADIO

THE NEW PATHFINDER "SUPER 10"

THE LATEST UP-TO-THE-MINUTE SUPERHETERODYNE

USING
4-58, 2-56, 1-2B7,
1-5Z3, 2-2A3
ROLA DYNAMIC
SPEAKER ESPECIALLY
DESIGNED FOR
PUSH PULL
2A3

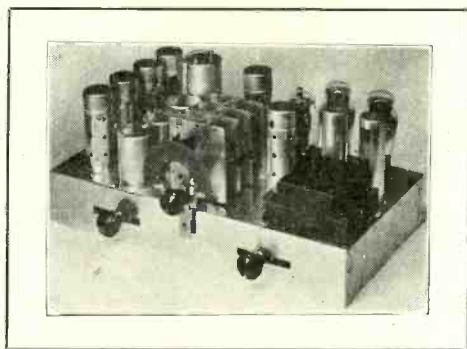

AUTOMATIC
VOLUME CONTROL
10 k.c. SELECTIVITY
OUTSTANDING
QUALITY
THE FINEST QUALITY
PARTS TO BE BUILT
ON A 10 x 18 BASE

Released in Kit Form Complete with Speaker \$20⁷⁵ KIT LESS TUBES

MAIL ORDERS PROMPTLY FILLED

DIAGRAMS FREE

THOR'S BARGAIN BASEMENT

167 GREENWICH STREET

between Cortlandt and Liberty Sts.

NEW YORK CITY

Mr. SERVICEMAN

Take a tip! Get Rider's Volume II of the Perpetual Trouble Shooter's Manual. Buy it today. Don't wait until you cannot repair a receiver because you do not have the data.

FREE. If you are a Service Man, write for the color code chart of the resistors used in Atwater Kent receivers. Enclose 3c to cover postage.

RADIO TREATISE CO., Inc.
1440 Broadway New York City

and "RADIO NEWS" RADIO WORLD

BOTH FOR ONE Year \$7.00 Canadian and Foreign \$1.00 extra

You can obtain the two leading radio technical magazines that cater to experimenters, service men and students, the first and only national radio weekly and the leading monthly for one year each, at a saving of \$1.50. The regular mail subscription rate for Radio World for one year, a new and fascinating copy each week for 52 weeks is \$6.00. Send in \$1.00 extra, get "Radio News" also for a year—a new issue each month for twelve months. Total, 64 issues for \$7.00.
RADIO WORLD, 145 West 45th Street, New York, N. Y.

STATIONS BY FREQUENCIES

Frequency list, broadcasting stations, call, owner, location, power, wavelength, United States, Canada, Cuba, Mexico and Newfoundland. In Mar. 18th, 1933, issue of Radio World. Send 15c per copy to Radio World, 145 West 45th Street.

PUSH-PULL DIAMOND

A dual-range receiver, 1550—535 kc, 1525—4200 kc, using a perfected superheterodyne circuit, frequency-stabilized oscillator and electron coupling between modulator and oscillator. Ten tuned circuits, four variable. Two stages of t-r-f, tuned modulator, tuned oscillator, with switch for wave-changing. Output 15 watts from 2A3's in push-pull. Full-wave second detector, with 56 driver of output. 52 mfd. of B filter capacity. Automatic volume control of two i-f tubes. Automatic inter-channel noise suppression. Selectivity enough to blot out strong locals

10 kc removed from distant station. No squeals whatever.

Tubes used: Five 58's; two 55's; one 56; two 2A3's; one 5Z3. Wired Model of 12-Tube Push-Pull Super Diamond, including speaker, tubes and everything else, except cabinet. Lined up and padded by experts. Licensed. **\$41.27**

Complete parts, speaker, tubes, everything except cabinet. **\$37.77**

Direct Radio Co.
143 West 45th Street
New York, N. Y.

NEW RADIO AMATEUR'S HANDBOOK, 180,000 words, 207 illustrations, 218 pages (10th edition, issued 1933). Issued by the American Radio Relay League. Price, \$1.00 per copy. Radio World, 145 West 45th Street, New York, N. Y.

ANDERSON'S AUTO SET

Designed by J. E. ANDERSON

FOREIGN RECEPTION ON 6-INCH AERIAL

This new auto set is the most sensitive ear receiver we have ever come across. Mexican and Canadian stations were tuned in from New York City on a 6-inch aerial. The circuit, an 8-tube superheterodyne, with automatic volume control. The complete parts, including set chassis and set shield, battery box, remote control, battery cable, all condensers, resistors and coils, speaker with shielded cable; and a kit of RCA tubes (two 239, two 238, two 237, one 89, and one 85) are supplied less serial. Cat. 898-K @.....\$34.60
Wired model, licensed by RCA, with complete equipment, less aerial, but including RCA tubes. Cat. 898-W.....\$37.40

DIRECT RADIO CO.

143 West 45th St. N. Y. City

POWERTONE A. C. & D. C. UNIVERSAL Short Wave Receiver

With Hammarlund Parts

Complete Kit of Parts

\$7.95



Wired with Coils . . . \$9.95

Get your share of the thrills of short wave reception! Here is a "best" of an all-round short wave receiver that can be connected to any current without batteries. Unlimited station broadcasts can be picked up with the Powertone Universal.

- *25 or 60 cycles.
- *Hammarlund tuning condenser and regeneration control.
- *Lynch metallized resistors.
- *Full-vision vernier dial.
- *QCTO form coils (15-200 meters).
- *Hinged-top black crackle finish cabinet.
- *Tubes: 1-43, 1-78 and 1-25Z5.

BEGINNER'S TWIN

With Hammarlund Parts

Uses two 2-volt, 250 low current tubes. Consistent long wave reception. Picks the station you want, excluding all others.

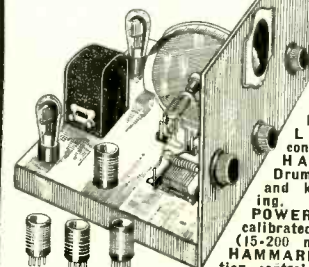

HAMMARLUND tuning condenser.

HAMMARLUND Drum Dial-Precision and knife-edge tuning.

POWERTEST Meter, calibrated plug-in coils (15-200 meters).

HAMMARLUND regeneration control.

HIGH QUALITY Audio Transformer.
Kit with drilled panel, base-blueprints, 4 coils, etc. \$7.95
Wired, with coils 8.95
TRY-MO RADIO CO., Inc., Dept. RW-5
Mail Order—85 Cortlandt Street, New York City
178 Greenwich St. — N. Y. C. — 179 Greenwich St.

Send for New 108-Page Catalog

CHARACTERISTICS CHART

All the receiver tubes, and some others, under the following groups: Detectors and Amplifiers, Power Amplifiers, Rectifiers, Phototubes, Regulators. Two full pages, also page of descriptive text. In Radio World of April 1, 1933. 15c a copy, or send \$1.00 for trial subscription of 8 weeks, including April 1. Radio World, 145 W. 45th St., New York City.

ROLAND BURKE HENNESSY
Editor

HERMAN BERNARD
Managing Editor

RADIO WORLD

The First and Only National Radio Weekly
TWELFTH YEAR

J. E. ANDERSON
Technical Editor

J. MURRAY BARRON
Advertising Manager

Vol. XXIII

MAY 20th, 1933

No. 10. Whole No. 582

Published Weekly by Hennessy Radio Publications Corporation, 145 West 45th Street, New York, N. Y.

Editorial and Executive Offices: 145 West 45th Street, New York
Telephone: BR-yant 9-0558

OFFICERS: Roland Burke Hennessy, President and Treasurer; M. B. Hennessy, Vice-President; Herman Bernard, Secretary.

Entered as second-class matter March, 1922, at the Post Office at New York, N. Y., under Act of March 3, 1879. Title registered in U. S. Patent Office. Printed in the United States of America. We do not assume any responsibility for unsolicited manuscripts, photographs, drawings, etc., although we are careful with them.

Price, 15c per Copy; \$6.00 per Year by mail. \$1.00 extra per year in foreign countries. Subscribers' change of address becomes effective two weeks after receipt of notice.

No Hum in This Small But Mighty A-C SHORT-WAVE COMBO

By Warren J. Elder

A LARGE number of short-wave listeners prefers the single-tube tuner, reporting that if the constants are chosen properly the results are as good as from much more elaborate sets. The tuner is always regenerative and is of course open to the objection that if it is improperly operated it will cause interference. However, if it is operated just below the oscillating point, where sensitivity is greatest, it will not cause interference.

The conventional regenerative one-tube circuit is shown followed by two stages of audio-frequency amplification. The 58 is used as regenerative detector, the 56 as first audio driver, and the 2A5 as the output tube. The rectifier is a 280. Thus there are four tubes in all, and yet the performance will be exceptionally good, if not too great a departure is made from the prescribed constants.

Foreign Stations Regularly

Originally the circuit was built with three tubes, that is, the 56 omitted, and some foreign stations were brought in with speaker volume, even around 20 meters, although it became obvious that for real speaker performance the extra stage of audio would come in handy. Wilbur Newman, of 1515 East Thirty-second Street, Brooklyn, N. Y., built the three-tube model, and was enthusiastic about the regularity with which foreign reception, some of it on the speaker, was obtainable. He recommended the extra audio stage now included.

Newman built the set from a design submitted by a telephone engineer to a group of amateurs, and naturally one of the requirements was that the hum level should be low. It was so low that Newman reported it was impossible to tell from mere listening that the receiver was a-c operated, except that below 20 meters there was some trace of tunable hum. This could be reduced by increasing the reservoir filter capacity, designated "8 mfd. up." One might use two or three 8 mfd. condensers in parallel in this position.

However, not only must the filtration be excellent in the B supply, but other precautions against hum and stray feedback must be taken. It will be observed

that the B supply is separate from the receiver and that not only is a separate heater transformer used for the detector but that its secondary is center-tapped and between grounded center and each extreme there is a 1.0 mfd. condenser. The filament winding for the power tube, the new 2A5, is returned to the cathode of that tube.

Tuning Operation

The aerial may be a long one, and is connected to the grid circuit of the detector through a small variable condenser, marked 65 mmfd., as making this variable enhances sensitivity, even though a measure of detuning is reflected in the parallel tuned circuit in consequence. However, resonance is established by a balance between the two, and as the detuning does not represent much difference on the dial, the repeated attainment of resonance in actual practice is not difficult. Even calibration may be enjoyed, if the same aerial is used, since the calibration will give the position of the main tuning condenser with parallel trimmer at minimum, and the adjustment of the series antenna condenser is then made on the basis of the capacity setting as established in the main condenser.

As the frequencies increase—second from last and last band particularly—it becomes advisable to have some band-spread effect, and this is yielded by the small variable condenser across the main tuning condenser. Any midjet or junior condenser may be reduced, by plate removal, until there are only three plates left, except that if the condenser is of the type, now off the market, that has very small plate area, the total number of plates should be five.

The detector is of the grid leak type, the grid condenser being 0.0001 mfd. mica dielectric, and the grid leak 5 meg.

Grid Current Detector

It is important for sensitivity purposes that the leak be of a high value, as the larger the resistance, the greater the voltage difference across the terminals of the resistor when grid current flows. The action of the detector depends entirely on grid current. The signal and oscillation

amplitudes cause the grid to become positive, hence the grid acts for this purpose like the anode of any rectifier, rectifying only when the element is positive in respect to the cathode. The detector is thus a half-wave, half-cycle rectifier, as no rectification takes place, as explained, during the negative alternation.

A fixed tickler is coupled to the secondary, and oscillation will be present for this reason, provided that the plate or grid coil is connected in a particular direction, has enough inductance and is closely enough coupled. If there is no oscillation, reverse the connection to either winding, but do not reverse both connections, as that would get you right back at the starting point.

Throttle Control

Control of regeneration is effected by means of a throttle condenser. This is 0.0002 mfd., but good results have been obtained with capacities as low as 0.0001 mfd., which was what Newman used. However, the oscillation point may not be just the same for all constructions and all these tubes used, and it is well to select 0.0002 mfd., if you are to get a condenser anew, and then if oscillation is well controlled with much less than the maximum capacity ever in use, put a series condenser of 0.00025 mfd. between stator of the throttle condenser and the feedback coil connection to the r-f choke.

The effect of the throttle condenser is to establish a shunt feed, and this is a popular method of controlling a tuned grid oscillator. Much has been written for and against all types of regeneration and oscillation control, but it must be admitted that more receivers use the condenser for throttle than use any other method. This is not to say that other methods aren't good, also.

The principal load on the plate circuit of the detector is an audio-frequency choke, and this is from tap on a 30 millihenry radio-frequency choke to B plus. It is not vastly important that the r-f choke coil inductance be as stated, but it should be large and the distributed capacity must be small, otherwise at the very frequencies when the choking effect is most needed it will be absent, for even a small distributed capacity at very high

(Continued on next page)

SHIELDED BATTERY SET for Receiving Short Waves on Speaker

By Leo Tonry

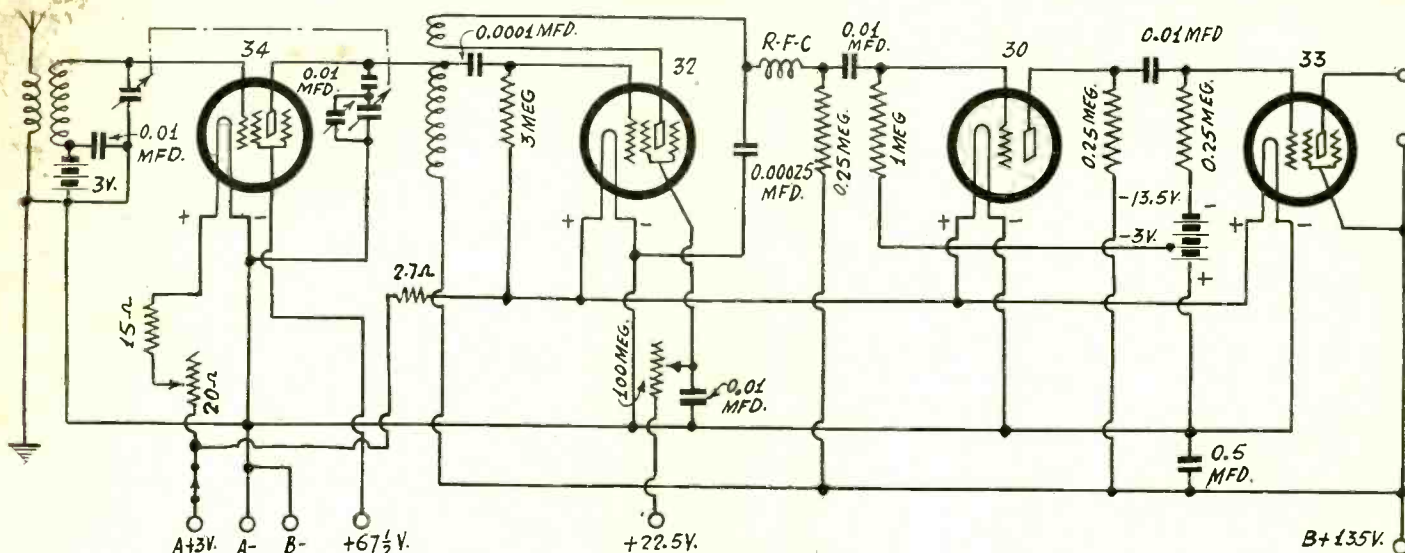

A short-wave receiver, using plug-in coils, and contained in a shielded box.

MORE battery-operated short-wave sets are in use in this country than a-c or line d-c operated short-wave sets, although the a-c devices are forging ahead and the day is perhaps not far distant when the a-c type will be the more numerous. Nevertheless, battery operation is popular, and this holds true even in locations where the user has a-c accessible. Several problems that arise with an a-c operated short-wave set do not come up in a battery receiver, and possibly that is one reason for the popularity.

Different on Short Waves

The set diagrammed is one built in a shielded box with hinge cover, so that the tuning mechanism and controls are right near the bottom, an unusual position, and the tuning condenser instead of having shaft horizontal has it perpendicular. Therefore a drum dial below engages the upright condenser shaft. This novel arrangement comes in handy indeed if the receiver is to be placed on any console or table and you intend to tune in stations when sitting down.

One eventually gets into the habit of tuning for short-wave stations when seated. With broadcast reception it is easy enough to get the station you want (if it is within range) by a twist of the dial, especially in reference to a frequency-calibrated dial. But more skill and patience are required for short-wave tuning, because the signal intensity is lower to start with, and the frequencies are so much higher that a small change in capacity accounts for a much larger change in frequency than anywhere in the broadcast band.

Screen Control of Feedback

About the only two circuits in wide use for short-wave reception are the regenerative t-r-f set and the superheterodyne. Even a single regenerative detector tube for earphone reception is a t-r-f set. A super has t-r-f and an intermediate frequency level besides, and of course there is an oscillator. On short waves, fortunately, t-r-f sets are very fine, not saying that supers aren't also, but the fact that

t-r-i sets have about passed out of the broadcast picture need not be held against t-r-f short-wave sets.

In short-wave sets using t-r-f there may be a stage of tuned r.f. ahead of the detector or not, but in the present instance it is included, as it can hardly be denied that under some circumstances greater selectivity is needed or desired than the single tuned circuit would provide, not

mentioning additional amplification obtainable. So the t-r-f stage is included, the 34 tube being used, as this is one of the 2-volt series. A negative bias of 3 volts is applied to this tube, and for short leads may be a separate battery, although the same battery that is used for biasing the 30 first audio tube might be utilized instead.

The antenna coil is just like the other coil, although the two transformers are hooked up differently. The small or primary winding of the antenna coupler is in the aerial-ground circuit. The larger winding is the secondary and is in the grid circuit.

The larger winding is tuned in the antenna coupler, and this is true also in the interstage example, the erstwhile primary being used now for feedback. This tickler is fixed and the control of regeneration in the grid-leak detector is by means of screen voltage adjustment. A very high value of rheostat is used, around 100,000-000 ohms being suggested.

A Protection

The coils are of the plug-in type, and may be commercial UX-base models, or may be wound from directions given in these columns for 0.00014 mfd. tuning. The two tuning condensers are ganged, but across one is a variable trimmer, of any small capacity, say, 30 to 50 mmfd. or thereabouts.

It will be noted that the plate circuit of the 34 and the grid circuit of the 32 are tuned by the condenser across the impedance coil. The coupling is close enough to make it tenable to consider the plate and grid of the respective tube as in parallel, so far as the signal is concerned.

Since one side (stator) of the tuning condenser goes to plate of the r-f tube, and other side (rotor) to ground, if any one or more of one set of plates touched any one or more of the other set of plates there would be a short circuit of the B voltage (135 volts), ruinous to the B batteries. To safeguard against this a high value of fixed mica condenser is put between the plate of the tube and the stator of the tuning condenser, and this, if 0.01 mfd., is large enough to render the

LIST OF PARTS

Coils

Two sets of short-wave plug-in coils for 0.00014 mfd. capacity.

One 30-millihenry honeycomb r-f choke coil.

Condensers

One two-gang 0.00014 mfd. tuning condenser.

Five 0.01 mfd. mica condensers.

One 0.5 mfd. bypass condenser.

One 0.00025 mfd. mica condenser.

One 0.0001 mfd. mica condenser.

Resistors

One 15-ohm fixed resistor filament.

One 20-ohm rheostat.

One 2.7-ohm fixed resistor (may be improved from a 6-ohm rheostat set to accord 2 volts on filament when the 20-ohm rheostat is at zero resistance).

One 3 meg. pigtail resistor.

One 100 meg. potentiometer with switch attached.

Three 0.25 meg. (250,000-ohm) pigtail resistors.

One 1.0 meg. pigtail resistor.

Other Requirements

Three UX and one UY sockets.

One antenna-ground connector.

One speaker connector.

One six-lead outlead cable.

One drum dial, scale, escutcheon.

One shielded box with hinge cover, over-all 9 $\frac{3}{4}$ wide x 8 $\frac{3}{4}$ high x 8 $\frac{3}{4}$.

One chassis with shield compartments, to fit inside shield cover.

capacity reduction, due to series capacity, virtually negligible.

May Use Long Aerial

However, since the two circuits, grid of first tube and plate of same tube, will not track perfectly, a manual trimmer is desirable, and since the capacity in the second section (plate circuit) has been reduced a bit, it is logical to put the additive capacity across the same condenser. This method holds good especially if the aerial has an excess over expected capacity. The average series capacity of an antenna may be put at 0.0002 mfd. It is so rated in standard testing systems using a dummy antenna. For short-wave reception with a set such as this it is expected that the aerial will be of about the same type used for broadcast reception, and the capacity in the first coil may be deemed therefore to lead the capacity in the second coil for that reason, and even though the output capacity of the tube itself may be a little greater than the input capacity.

Trimmer Experiment

Nevertheless, the manual trimmer, though put as directed, should be tried experimentally across the secondary of the antenna coil, as in some special instances this location is requisite. With the present circuit—one that omits any series antenna condenser—the more likely and logical position for this manual trimmer is nevertheless in the second tuned circuit.

A high value of grid leak is used—3 meg. being specified—and the grid condenser is 0.0001 mfd., which is a highly satisfactory capacity value for short waves, using the 30 tube. The return of the grid is made to positive, rather than to negative or zero bias, to insure flow of grid current under any and all conditions, even when there is no signal.

Square Law Detector

The grid current detector, such as this, is a good one, quite sensitive, lending itself readily to regeneration, and operating approximately on the square law, since the grid current, which runs counter to the cathode current, varies approximately according to the square of the amplitude.

We have noted the regeneration control, and high-resistance rheostat, but there is also a volume control, consisting of a 6-ohm rheostat. In series with a 15-ohm filament resistor in the positive leg feeding the 34 is a rheostat of 20 ohms, and this is used as volume control, also to check any slight oscillation as might be present in the first tube at the very highest frequencies to be tuned in.

It is advisable to have a volume control in addition to a regeneration control, as dependence on regeneration control alone is unsatisfactory from the viewpoint of selectivity. If regeneration control is relied on for performance of the dual function, then at maximum volume you would always have maximum selectivity, whereas it is often desirable to have maximum selectivity at less than maximum volume, which option the independent volume control affords. That is, sensitivity and selectivity may be controlled independently.

The R-F Choke

The radio frequency choke, RFC, should have a high inductance, it is not material just what, but the distributed capacity should be small. Inductances of values from 20 to 100 millihenries are suggested, and honeycomb type windings are in general preferable.

It can be seen that the tickler has radio frequency current flowing through it and thus the grid voltage is reinforced, but that at the return point of the fixed tickler

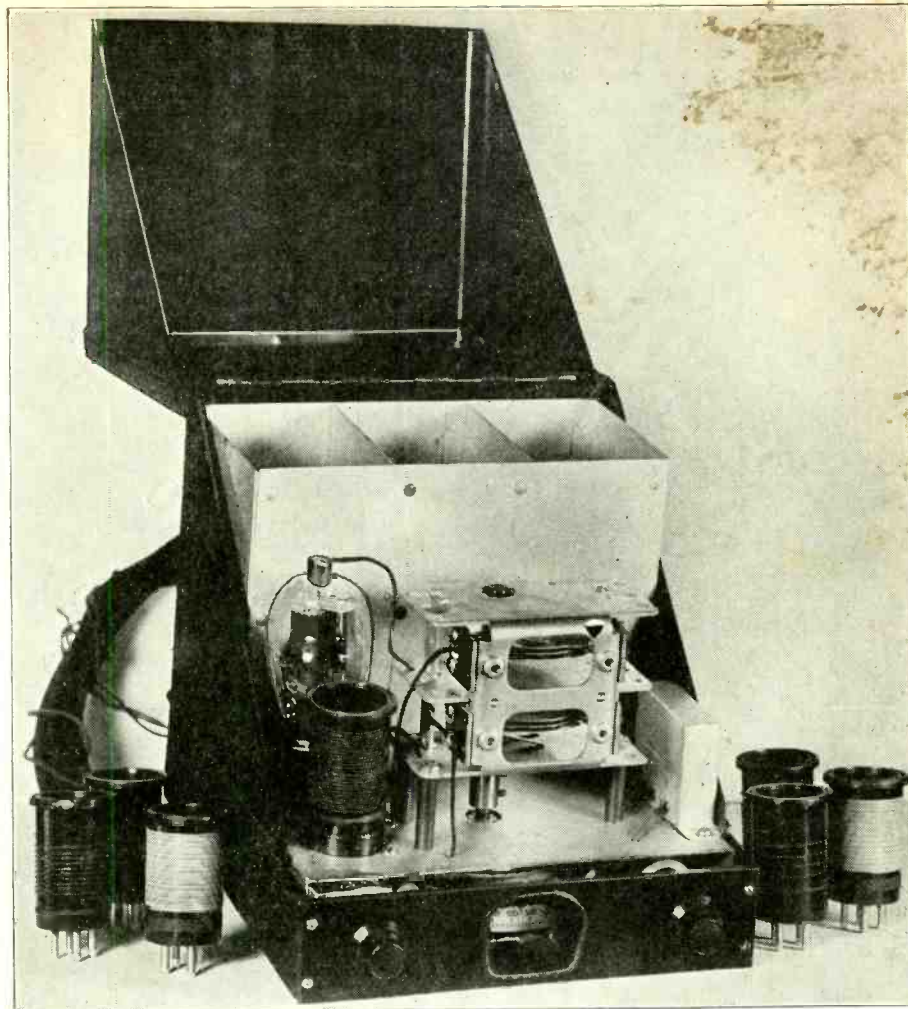

there is a bypass condenser of 0.00025 mfd., and following this is the r-f choke. The load resistor is 0.25 meg. (250,000 ohms), the value found quite suitable, all things considered, including regeneration ease.

Not too high values of grid leaks should be used, especially in the last stage, due to possibilities of grid emission. If grid current flows in these circuits the effective bias is lowered, because the signal voltage becomes positive faster than the leak tends to make the grid negative, so the tube loses bias, and this is equivalent to negative feedback. Quality is impaired and sensitivity is reduced. But the values of resistors, 1.0 meg. in one instance, 0.25 meg. in the other, render full protection against this trouble.

Currents Low

The 33 pentode is the output tube. The current in the filament is 0.26 ampere, as compared to the 0.06 ampere current in each of the three other filament circuits. So the total filament drain is .44 ampere and the total plate current drain (no signal) is around 20 milliamperes. At that rate two No. 6 dry cells, series-connected to afford 3 volts, and three medium-sized 45-volt B batteries, should last about five months, average use. If practical, however, get the large sized B batteries, as they should last nearly a year.

Inexpensive

It can not be complained that the set is expensive to operate, nor is the construction cost of parts high. All told, the outfit makes a compact, satisfactory and dependable short-wave receiver, one that will do its work nicely and consistently, and helps to bring short-wave reception to many who otherwise would have to forego this enticing pleasure.

THE NEW 2A6

DUPLEX-DIODE TRIODE
(High-Mu Triode)

TENTATIVE RATING AND CHARACTERISTICS

Heater Voltage (A. C. or D. C.)...2.5 Volts
Heater Current0.8 Ampere
Direct Interelectrode Capacitances—Triode Unit (approx.):

Grid to Plate1.7 $\mu\text{f.}$
Grid to Cathode1.7 $\mu\text{f.}$
Plate to Cathode.....3.8 $\mu\text{f.}$
Overall Length4-9/32" to 4-17/32"
Maximum Diameter.....1-9/16"
BulbST-12
CapSmall Metal
Base (For connections, see Note 1)
Small 6-Pin

TRIODE UNIT (Class A Amplifier)

Operating Conditions and Characteristics:

Heater Voltage2.5 Volts
Plate Voltage250 max. Volts
Grid Voltage-2 Volts
Amplification Factor100
Plate Resistance91000 Ohms
Mutual Conductance.....1100 Micromhos
Plate Current0.8 Milliampere

DIODE UNITS

Two diode plates are placed around a cathode, the sleeve of which is common to the triode unit. Each diode plate has its own base pin.

Note 1:

- Pin 1—Diode Plate
- Pin 2—Triode Plate
- Pin 3—Heater
- Pin 4—Heater
- Pin 5—Cathode
- Pin 6—Diode Plate
- Cap—Grid

Pin numbers are according to RMA Standards.

The 53 as Class A Driver and Class B Output

THE 53 is a heater-cathode type of tube combining in one bulb two high-mu triodes designed for Class B operation, state R. C. A. Radiotron Co., Inc., and E. T. Cunningham, Inc. It is intended primarily for use in the output stage of a-c operated radio receivers. In such applications, the 53 is capable of providing a power output of 10 watts at a plate voltage of 300 volts.

The triode units of this tube have separate external terminals for all electrodes except the cathode and heater, so that circuit design is similar to that of Class B amplifiers utilizing individual tubes in the output stage.

Besides its usefulness in the output stage, the 53 may also be adapted to the driver stage by connecting the two triode units in parallel. The tube then serves as a Class A amplifier and possesses characteristics such that it can deliver to a 53 in the Class B output stage adequate power with high gain and low distortion.

TENTATIVE RATING AND CHARACTERISTICS

Heater Voltage (A. C. or D. C.)	2.5 Volts
Heater Current	2.0 Amperes
Overall Length	4-11/16"
Maximum Diameter	1-13/16"
Bulb	ST-14
Base (Refer to Outline Dwg. No. 92S-4246)	Medium 7-Pin

CLASS B POWER AMPLIFIER

Plate Voltage	300 max. Volts
Dynamic Peak Plate Current (per plate)	125 max. Milliamperes
Average Plate Dissipation	10 max. Watts
Typical operation:	
Heater Voltage	2.5 2.5 Volts
Plate Voltage	250 300 Volts
Grid Voltage	0 0 Volts
Static Plate Current (per plate)	14 17.5 M'amps
Load Resistance (plate to plate)	8000 10000 Ohms
Nominal Power Output*	8 10 Watts

*With average power input of 350 milliwatts applied between grids.

CLASS A AMPLIFIER—AS DRIVER

The two grids are connected together at the socket; likewise the two plates.

Operating conditions and characteristics:	
Heater Voltage	2.5 2.5 Volts
Plate Voltage	250 294 Volts
Grid Voltage	-5 -6 Volts
Amplification	
Factor	35 35
Plate Resistance	11300 11000 Ohms
Mutual	
Conductance	3100 3200 Micromhos
Plate Current	6 7 M'amps

INSTALLATION

The base pins of the 53 fit a standard 0.855" pin-circle diameter seven-contact socket which may be installed to operate the tube either in a vertical or in a horizontal position. Base connections and external dimensions of the 53 are given in the outline drawing.

The bulb of this tube will become very hot under certain conditions of operation. Sufficient ventilation, therefore, should be provided to circulate air freely around the tube to prevent overheating.

The heater is designed to operate at 2.5 volts. The transformer winding supplying the heater circuit should be designed to

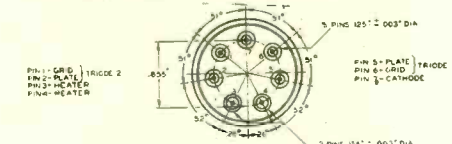
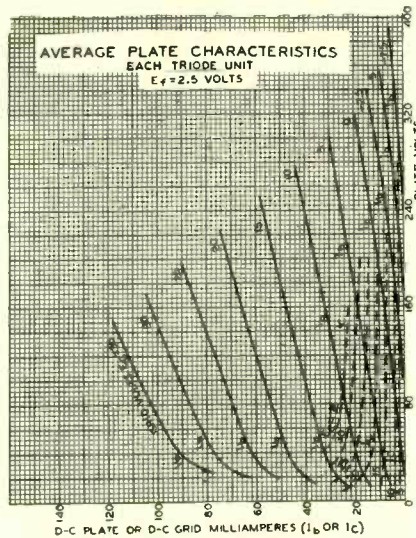

The curves at left show the plate current (I_b) and the grid current (I_c) of each triode of a 53 tube for different plate and positive grid voltages,

operate the heater at this recommended value for full-load operating conditions at average line voltage.

The cathode should preferably be connected directly to a mid-tap on the heater winding. If this practice is not followed, the heater may be biased negative with respect to the cathode by not more than 45 volts.

The grids for Class B and Class A service should be connected so as to give resultant tube characteristics suited to the particular service. Detailed information on connections is given under Application.

APPLICATION

Combining two triode units designed for Class B operation in a single bulb, the 53 is intended primarily for use in the Class B output stage of a-c operated receivers. It may also be used as a Class A amplifier (with triode units connected in parallel) to drive the 53 in the output stage.

As a Class B power amplifier, the 53 is used in circuits similar in design to those utilizing individual tubes in the output stage. It requires no grid bias, since the high-mu feature of the triode units reduces the steady plate current at zero bias to a relatively low value.

During operation of this tube as a Class B amplifier, the grids of the two triode units are alternately swung positive each half cycle. Considerable power is required to do this under ordinary conditions. If, however, the secondary emissivity of the grids were made nearly equal to unity, the required power to swing the grids could be appreciably decreased. Tubes possessing this feature can be constructed, but the secondary emissivity is not independent of signal voltage and frequently causes negative grid current. Furthermore, secondary emission behaves errati-

AVERAGE PLATE CHARACTERISTICS CLASS A OPERATION—TRIODE UNITS IN PARALLEL $E_f = 2.5$ VOLTS

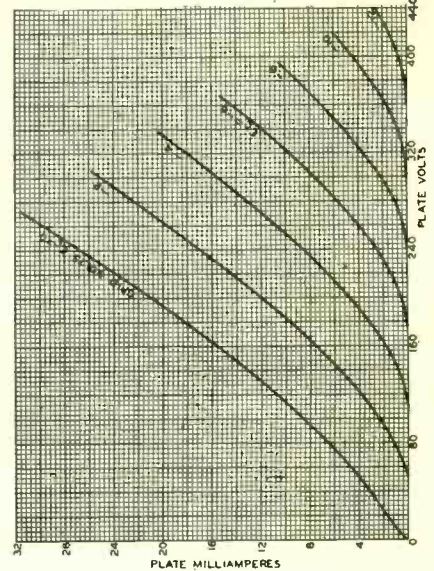

Class B. At right, plate current for different plate voltages and negative grid bias values of a 53 tube, Class A operation.

cally during the life of the tube. Thus, to have a Class B tube which will give uniform results throughout its life, it is preferable from the tube design standpoint, to eliminate secondary emission insofar as possible even at the expense of greater driving power. Unless tubes for use as Class B amplifiers are capable of producing uniform results throughout their life, it is practically impossible to design circuits to use them.

Plate Current Varies Widely

The d-c plate current required in Class B circuits fluctuates under normal operating conditions. The power supply, therefore, should have good regulation to maintain proper operating voltages regardless of the current drain. For this purpose, a suitably designed power unit should be employed. The rectifier tube should have reasonably good regulation over the operating range. In some circuit designs, a vacuum-type of rectifier tube can be used, while in others a mercury-vapor type may be needed to provide the required regulation. As a factor in obtaining good regulation, the filter chokes and the transformer windings should have low resistance. In the design of a power supply for a Class B amplifier, consideration should be given to economical distribution of losses. Also, the power supply should be designed to take care of the average power demands with sufficient regulation to meet the peak power demands.

As previously pointed out, the grids of the 53 are alternately operated sufficiently positive to cause grid current to flow in their input circuits. This feature imposes a further requirement on the preceding amplifier stage. It must supply not only the necessary input voltage, but it must be capable of doing so under conditions

where appreciable power is taken by each grid of the Class B amplifier tube. Since the power necessary to swing the grid positive is partially dependent on the plate load of the Class B tube, and since the efficiency of power transfer from the preceding stage is dependent on transformer design, it is apparent that the design of a Class B audio power amplifier requires that more than ordinary attention be given to the effects produced by the component parts of the circuit. These effects may be produced in the first-stage amplifier by the design factors of the power-output stage. For this reason, the design of a Class B audio amplifier with its driver stage is somewhat more involved than for a Class A system, and must be checked for each change in the component parts.

A complete discussion of design features for Class B amplifiers would be rather extensive, but certain outstanding points may be mentioned. The interstage transformer is the link interconnecting the driver and the Class B stage. It is usually of the step-down type, that is, the primary input voltage is higher than the secondary voltage supplied to the grids of the power output tube. Depending upon conditions, the ratio of the primary of the interstage transformer to one-half its secondary may range between 1.5/1 and 5.5/1.

Factors Affecting Ratio

The transformer step-down ratio is dependent on the following factors:

1. Type of driver tube
2. Type of power tube
3. Load on power tube
4. Permissible distortion
5. Transformer efficiency (peak power)

The primary inductance of the interstage transformer should be essentially the same as if the transformer were to be operated with no load, that is, into an open grid. Since power is transferred, the transformer should have reasonable power efficiency. It should be noted that the power output and distortion are often critically dependent upon the circuit constants which should, therefore, be made as nearly independent of frequency as possible. This applies particularly to the interstage coupling transformer and to the loudspeaker. Since it is difficult to compensate for leakage reactance of the coupling transformer without excessive loss of h-f response, the leakage reactance of this transformer should be as low as possible.

The type of driver tube chosen should be capable of handling sufficient power to operate the Class B amplifier stage. Al-

lowance should be made for transformer efficiency. It is most important, if low distortion is desired, that the driver tube be worked into a load resistance higher than the normal value for optimum power output as a Class A power amplifier, since distortion produced by the driver stage and the power stage will be present in the output.

Notes on Class B

The following notes on Class B amplifier circuits are of value from the design viewpoint:

The load on the driver tube or tubes is chosen higher than for undistorted power rating to hold overall distortion to a minimum. For a single triode driver, its minimum plate load should be approximately 2 to 4 times the plate resistance of the driver tube. For a push-pull triode driver stage, its minimum plate load per tube should be approximately equal to the plate resistance of an individual tube. This ratio for push-pull operation is permissible principally because of elimination of second harmonic distortion. This minimum plate load is the value used for calculating peak power transformer efficiency.

An interstage transformer with high step-down ratio causes low distortion in the Class B input circuit, but limits the available signal. A satisfactory transformer design makes use of grid distortion to cancel a part of the distortion produced in the plate circuit of a Class B stage. For this reason, the transformer step-down ratio must not be too great. Resistance losses of the primary and secondary may be distributed on the basis of the most economical design. It is important to consider that only one-half of the secondary furnishes power at a time.

The load values for the Class B amplifier stage given under Rating and Characteristics will change slightly with available input if maximum output and low distortion are desired. It is important to consider that only one-half of the primary of the output transformer furnishes power at one time.

Class A Operation

For Class A amplifier triode operation of the 53, the two grids are connected together at the socket; likewise, the two plates. These connections place the two triode units in parallel. Operation of the tube is then similar to any Class A power amplifier triode. Refer to Rating and Characteristics for operating conditions.

As a Class A amplifier triode, the 53 may be employed in the driver stage of Class B amplifier circuits, and thus reduce

the number of tube types necessary in a receiver. When operated in this way with a plate supply of 300 volts and corresponding grid bias, the 53 is capable of supplying a power output upwards of 400 milliwatts. The load into which the driver works will depend largely on the design factors of the Class B amplifier. In general, however, the load will be between 20000 and 40000 ohms.

The d-c resistance in the grid circuit of the 53 operating as a Class A amplifier may be as high as 0.5 megohm with self-bias. With fixed bias, however, the resistance should not exceed 0.1 megohm.

THE NEW 6A4

POWER AMPLIFIER PENTODE
(6.3-Volt Filament)

TENTATIVE RATING AND CHARACTERISTICS

Filament Voltage (A. C. or D. C.)	6.3 Volts
Filament Current	0.3 Ampere
Plate Voltage—	
100 135 165 180 max. Volts	
Screen Voltage—	
100 135 165 180 max. Volts	
Grid Voltage—	
-6.5 -9 -11 -12 Volts	
Plate Current—	
9 14 20 22 Milliamperes	
Screen Current—	
1.6 2.5 3.5 3.9 Milliamperes	
Plate Resistance—	
83250 52600 48000 45500 approx. Ohms	
Amplification Factor—	
100 100 100 100 approx.	
Mutual Conductance—	
1200 1900 2100 2200 Michomhos	
Load Resistance—	
11000 9500 8000 8000 Ohms	
Power Output (9% total harmonic distortion)	0.31 0.7 1.2 1.4 Watts
Maximum Overall Length	4-11/16"
Maximum Diameter	1-13/16"
Bulb	ST-14
Base (For connections, see Note 1)—	Medium 5-Pin

Note 1:

- Pin 1—Grid
- Pin 2—Plate
- Pin 3—Filament+
- Pin 4—Filament—
- Pin 5—Screen

Pin numbers are according to RMA standards.

Note 2: Transformer or impedance input-coupling devices are recommended. If, however, resistance coupling is employed, the grid resistor should be limited to 0.5 megohm.

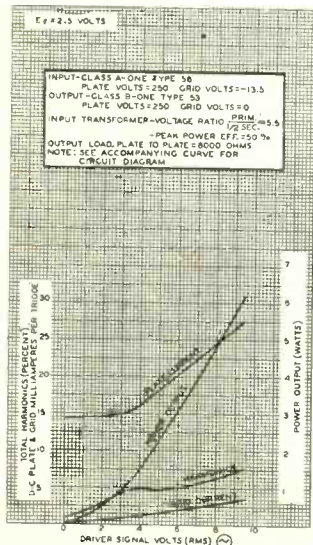

The output characteristics of a Class B, Type 53 amplifier when driven by a Class A, Type 56, with 250 volts on the plates.

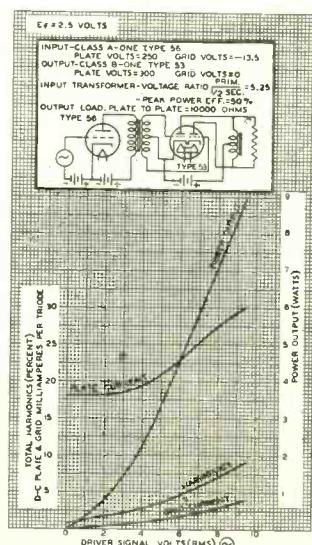

The output characteristics of the same arrangement as in the preceding except that the plate voltage is 300 volts.

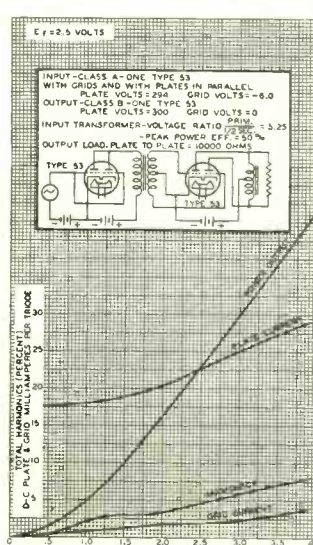

This shows the output of a 53, Class B, amplifier when driven by a 53, Class A, with the two triodes in parallel.

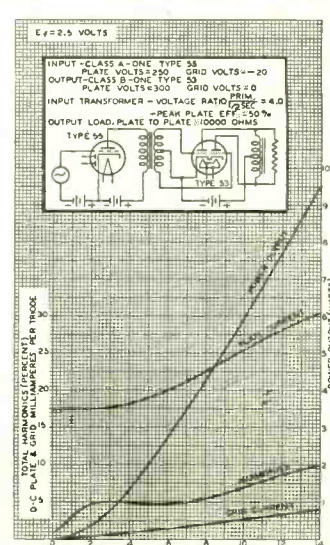

The output characteristics of a 53, Class B amplifier when driven by a 55 under conditions indicated.

CURES FOR HUM

In Universal AC-DC Receivers

APPLICATION NOTE ON HUM ELIMINATION IN UNIVERSAL RECEIVERS

BECAUSE of cost requirements, lack of chassis space, and plate supply voltage limitations, the filter system for the power supply in compact transformerless a-c and d-c receivers must be small. As a result, troublesome hum is often encountered in these sets. However, a careful study of the receiver circuit and the arrangement of the chassis components will nearly always reveal a remedy for excessive hum.

Sources of Hum

The principal sources of hum in small receivers are:

(1) The power supply system, in general, is the most common source of hum. The necessity of using low-capacity condensers and small filter chokes may result in ripple voltage high enough to cause audible hum.

(2) The speaker-field coil is also a common source of hum. Ripple voltages in the speaker-field power supply are induced in the voice coil, causing objectionable hum.

(3) The pick-up of stray electro-static or electro-magnetic fields is another source of hum.

(4) The rectifier tube is sometimes the source of modulation hum. The signal voltage entering the set over the power line may be modulated with the rectified a-c output from the rectifier, and then reradiated, causing hum in the set.

(5) The filaments or heaters of the tubes may, under certain circuit conditions, occasion a small amount of hum due to the effects of the electro-magnetic fields produced by the a-c filament or heater supply.

(6) In heater-cathode types of tubes, leakage between the heater and cathode, due to the high a-c potential difference between them, may sometimes cause hum.

The first two sources of hum mentioned are undoubtedly the most common and the most troublesome. A small amount of hum in small transformerless receivers due to these sources must be tolerated in order to obtain a small size and low-cost receiver.

Location of Hum Sources

The first step in the elimination of hum is naturally the location of its source. By shorting first the input and then the output of each stage successively, hum originating in any one stage can be isolated. If hum persists after the input to the last audio stage has been shorted, the source of trouble probably lies in the power-supply system. To determine if hum is due to ripple voltage in the speaker field, short the output transformer or the speaker voice-coil and note the results. Any hum which continues is due to ripple voltages in the speaker field.

Hum Elimination

HUM DUE TO POWER SUPPLY

There are a number of steps to be tried in the elimination of hum originating in the power-supply system.

(1) In many cases, balancing both sides of the line to the chassis through condensers will materially reduce hum. The ca-

capacity of these condensers should be about 0.1 mfd.

(2) The use of each half of the 25Z5 to supply a separate load circuit will usually achieve a reduction in hum. The speaker field can be supplied from one plate and its cathode, and the plate voltage for the tubes can be supplied from the other plate and its cathode. In a few cases it may be found that this arrangement, due to other circuit conditions, causes hum. In such cases, the plates and cathodes of the 25Z5 should be operated in parallel.

(3) In circuits which employ separate loads for the two halves of the 25Z5, an increase in the capacity of the condenser by-passing the speaker field may reduce hum. Of course, in sets using both plates and cathodes of the 25Z5 in parallel, the filter condenser and the condenser by-passing the speaker field are the same.

(4) Perhaps the most effective, but also the most expensive, method of reducing hum due to the power supply is to increase the capacity of the filter condenser. The maximum permissible size and cost of the condenser must be taken into consideration when this is done. However, increasing the capacity of the filter condenser has the further advantage that an improvement in the regulation of the power supply will result.

(5) It is sometimes possible to eliminate hum by introducing into some circuit an a-c voltage of equal value and opposite phase to the ripple voltage.

Hum Due to Speaker-Field Supply

An adjustment of the hum-reducing coil on the loudspeaker will usually result in a reduction of the hum to a satisfactory value. The number of turns on the hum-reducing coil should be approximately one-half the number of turns on the voice coil. The resistance of the hum-reducing coil should be low compared to that of the voice coil.

Reradiation from Rectifier

Modulation hum in small universal sets frequently is due to the fact that the power lines carry the signal voltage into the rectifier tube. Here the signal voltage is modulated with the rectified a-c hum-voltage, and then, either reradiated to the antenna, or to other circuits in the receiver.

A 0.05 to 0.25 mfd. condenser across the power line will usually remedy this difficulty.

Hum Due to Stray Fields

The pick-up by radio-, intermediate-, or audio-frequency circuits of stray electro-magnetic or electro-static fields may cause objectionable hum in the set. There are two steps to be tried in the elimination of this hum.

(1) Hum originating in any stage usually can be effectively removed by the use of a filter in the grid, screen, or plate circuit of the stage, or stages, at fault. This filter should consist of a resistance of 10,000 to 250,000 ohms and a condenser of 0.05 to 0.1 mfd. Naturally, it will be desirable to use the lowest value of resistance and capacity necessary to accomplish the desired results.

(2) A rearrangement of the chassis parts may sometimes be necessary to

eliminate hum caused by stray fields. Parts and circuits carrying a-c voltages should be separated as far as possible from parts and circuits carrying signal voltages. Stray fields from the rectifier tube and filter choke will be picked up by the detector or audio-frequency tubes unless they are properly placed and separated. Any audio-frequency transformers should be kept away from a-c fields.

Filaments or Heaters

The a-c fields surrounding the filaments or cathodes may sometimes cause hum due to their control effect on plate current. In sets where the heaters or filaments are operated in series, a rearrangement of the heater sequence may reduce hum. The heaters of the more critical tubes should be nearest the side of the line to which the negative plate-supply is connected. Usually the second detector is the most critical, then the mixer (first detector), then the output tube. Their heaters should be arranged in that order with respect to the negative side of the line. The heater of the rectifier should be next to the ballast resistor which is connected to the high side of the line.

In sets employing a voltage-doubler arrangement, the heaters of the most critical tubes should be connected to the side of the line terminating between the condensers of the doubler. Also, if the speaker field is used as a filter choke it should be placed in the negative side at the "B" supply to reduce the potential difference between the cathodes and heaters.

Heater-Cathode Leakage

The severe conditions imposed upon tubes operated with their heaters in series across the line sometimes causes hum. The relatively high potential applied between the heaters and the cathodes may cause leakage currents of sufficient magnitude to cause trouble. To eliminate hum due to these causes, the following steps should be taken.

(1) The heaters of the tubes which are most critical to hum should be placed next to the negative side of the line. Trying various arrangements of the series heater connection will result in a combination having minimum hum.

(2) If a rearrangement of the heater series fails to give satisfactory results, it may be necessary to enlarge the by-pass condensers around the self-biasing resistors. Capacities up to 5 mfd. are desirable in the detector and last audio stage. Usually, low-cost low-voltage condensers can be used.

In spite of the severe operating conditions imposed upon the tubes, troubles due to heater-cathode leakage are being steadily decreased by improvements in the tubes themselves. The success of these improvements can be demonstrated by comparison of hum obtained when the set is totally a-c operated and when operated with heaters separately supplied from a good d-c source. In such a comparison, after the set has been adjusted for all other causes of hum, it will be noted that hum which is chargeable to heater-cathode leakage is relatively small.

—From RCA Radiotron Co., Inc., and E. T. Cunningham, Inc.

UNIVERSAL OSCILLATOR

25Z5 Rectifier in Circuit Useful on A-C or D-C for Measurements

By Einar Andrews

WE HAVE universal receivers, both broadcast and short-wave. They have their uses. But so far we have not had a universal oscillator for test purposes. Such an oscillator would certainly be useful to a service man, who may be called on to test receivers of all kinds. If he has a universal oscillator he can plug it into the line whether the supply is alternating or direct, and the circuit will work equally well in either case.

In Fig. 1 is the circuit diagram of an oscillator that can be used on either a.c. or d.c. The oscillator proper is a 37 tube, the rectifier is a 25Z5, and the output tube is a 43. There are several reasons for using the 43. First, it is desirable to have a means of varying the output of the oscillator without seriously affecting the frequency of oscillation. The potentiometer in the grid circuit provides this means. Second, it is desirable at times to have a very large output from the oscillator. The 43 is a power tube and therefore it does provide a way of getting a strong output. Third, the excess line voltage must be dropped, and it might as well be dropped usefully by heating the cathode of the power tube. It may be desirable to modulate the output of the oscillator without tampering with the oscillating circuit. The output may be modulated by impressing an audio frequency voltage in series with the screen lead of the 43.

Oscillator Type

The oscillator is of the tuned plate type, parallel fed. This type of feed is used to permit grounding of the variable condenser C. A condenser of 0.1 mfd. is put between the plate of the tube and the tuned circuit. The object of using such a large value is to prevent a phase shift. A small condenser, one of 0.0001 mfd. is used in the grid circuit, mainly because a larger value might cause blocking on certain settings of the tuning condenser.

If the oscillator is to be used only for broadcast frequencies, the tuning condenser should be a 350 mmfd., the size used for tuning most present-day receivers. The tuning inductance, then, should also be a broadcast coil.

If an oscillator is built along the line given in Fig. 1, it should be tunable to a wide range of frequencies. It should cover intermediate frequencies as well as high and broadcast frequencies. This will require a set of coils. The different coils may be picked up with a switch or they may be of the plug-in type. It is more convenient to use the switch method, although the oscillator will require more room that way.

The switch required is a two-pole, multi-throw, the number of throws depending on the number of coils necessary to cover the required frequency range.

Tuning Unit

The condenser C may have a maximum capacity of 140 mmfd. This is satisfactory for the highest frequencies, for it is the size almost universally used in short-wave tuners. It is also all right on the intermediate frequencies although it requires a rather large number of coils

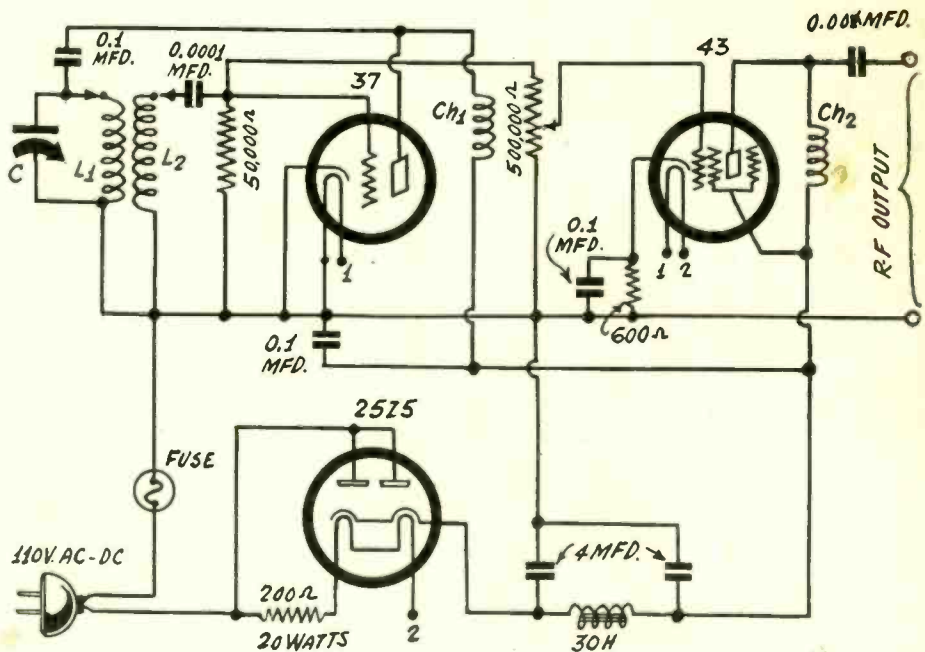

FIG. 1
This is the circuit of a universal oscillator of the tuned plate type.

to cover the frequency range. But there is an advantage in that, for when a given coil covers only a narrow range of frequencies very accurate settings are possible.

For the purpose of selecting the coils we may assume that the highest value of the capacity across the coil L1 is 150 mmfd. and that the lowest capacity is 25

mmfd. This makes the ratio of maximum to minimum capacity 6, and the frequency ratio 2.45. If we do not allow any overlap, this ratio will require 5 coils to cover the range from 150 to 15,000 kc. Six coils will provide plenty of overlap.

In the following table are shown the inductances required to cover the various frequencies range:

LIST OF PARTS

Coils

- One set of oscillator coils as described.
- One choke of about 85 m.h. made up of smaller chokes in series.
- One 10-millihenry choke.
- One 30-henry choke.

Condensers

- C—One 140 mmfd. tuning condenser with vernier dial.
- One 0.0001 mfd. condenser.
- One 0.001 mfd. condenser.
- Three 0.1 mfd. condensers.
- Two 4 mfd. condensers.

Resistors

- One 50,000-ohm grid leak.
- One 500,000-ohm potentiometer.
- One 600-ohm bias resistor.
- One 200-ohm, 20-watt ballast resistor.

Other Requirements

- One five-contact socket.
- Two six-contact sockets.
- One double pole, six throw switch.
- One line fuse, 3-ampere.
- One line switch (may be attached to potentiometer).
- One six-foot cord and plug.
- One small chassis.
- One 37, one 43 and one 25Z5 tube.

L1	Low frequency	High frequency
7.5 m.h.	150 kc	367.5 kc
1.3 m.h.	360 kc	882 kc
234 u.h.	850 kc	2,080 kc
42.1 u.h.	2,000 kc	4,900 kc
8.34 u.h.	4,500 kc	11,000 kc
1.69 u.h.	10,000 kc	24,500 kc

In each case the grid winding, L2, may be equal to the tuned winding, and the coupling between the two should be as close as practical. It is not necessary to get just these values of inductance, for the circuit is to be calibrated. An 8 or 10 millihenry r-m choke can be used for the largest coil—two of them, one for the tuned and one for the untuned windings. The two should be placed end to end as close as they can be placed.

The second largest coil can also be obtained in the form of two r-f chokes. To get these inductances correct, larger coils should be stripped down. This is best done experimentally, for only that way can the overlapping be made low. It does not have to be as large as indicated in the table.

Broadcast Coil

The third largest coil covers a large part of the broadcast band, and the inductance needed is about the same as (Continued on next page)

THE PATHFINDER

By Engineering Department

HERE is the latest Pathfinder receiver, a ten-tube superheterodyne incorporating many of the latest tubes. It has all those characteristics that a ten-tube receiver should have, high amplification, high selectivity, great volume, duplex diode detection, resistance and push-pull audio amplification, automatic volume control, tone control, provision for phonograph playing, manual volume control in the input of the audio amplifier, and step manual control in the first detector.

These are the main features. There are many details of design in addition that make for an outstanding receiver. For example, it has three intermediate frequency stages with three 175 kc intermediate frequency transformers, all doubly tuned and the last one centertapped for full wave detection.

Good Filtering

Another important feature of the circuit is the thorough filtering of the voltage supply circuits. Let us start with the bias resistances. On the first tube we have a 0.1 mfd., on the first detector we have 0.25 mfd., on each of the intermediates, 0.25 mfd., on the 2B7 pentode, 25 mfd., on the 56 audio, 2 mfd., and on the push-pull amplifier, 2 mfd. It is noteworthy that the condenser across the bias for the pentode a-f tube is 25 mfd.

The screens of the various tubes are also well filtered. In the screen lead of the first tube is a 5,000-ohm resistor shunted by a condenser of 0.25 mfd. In the first detector screen is a resistance of 15,000 ohms and it is shunted by a condenser of 0.5 mfd. In the screen lead of each intermediate amplifier is a 5,000-ohm resistor, and each is shunted, to ground, by a condenser of 0.1 mfd. In the screen lead of the pentode of the detector is a resistance of 250,000 ohms, shunted to the cathode by a condenser of 0.5 mfd. The high resistance is necessary to make the pentode truly an a-f amplifier.

The common leads to the screens and the plate to the oscillator are by-passed by a 2 mfd. condenser.

The plates are not individually by-passed but all the leads are returned to a single point where an 8 mfd. electrolytic condenser shunts all the signal fluctuations to ground.

Grid Filtering

Thorough filtering is done in the grid circuits where the grids are returned to the a. v. c. source. Thus there is a 50,000-ohm resistor in each of the two leads, and each is shunted to ground by a condenser of 0.25 mfd. There is no chance of any intermediate frequency voltages to get back from the detector to the amplifiers. The usual 0.5-megohm resistor is connected in the common grid return lead. Its main function is to prevent short circuiting of the audio signal, or part of it, through the grid filters. But it also aids in preventing signal feed back.

Bias on Tubes

In the input circuit of the audio amplifier, that is, of the 2B7 pentode, is a 0.00025 mfd. condenser across the 0.5-megohm potentiometer load resistance and a condenser of 0.001 mfd. from the slider to the centertap of the coil. As an alternative, this condenser might be con-

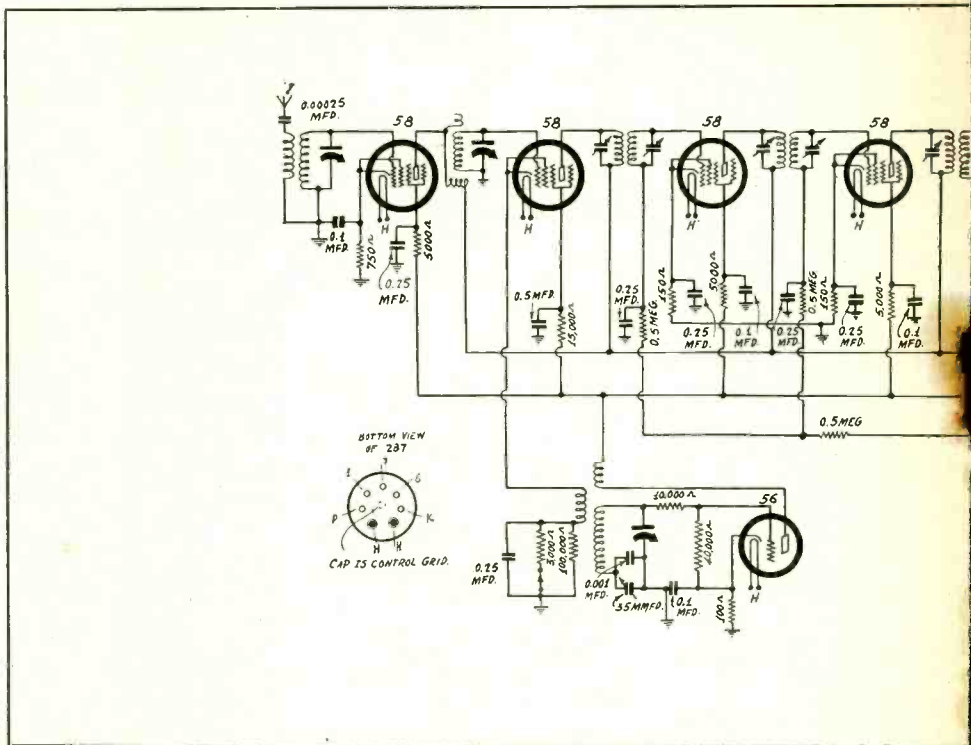

This is the circuit diagram of the 10-tube Pathfinder superheterodyne receiver. The quality is...

nected between the slider and the cathode of the tube.

Fixed bias is used on all the tubes, including the 2B7 pentode, except in so far as the bias on the intermediate tubes is varied automatically by the signal. The radio frequency amplifier, a 58, is biased by a 750-ohm resistor. The modulator, also a 58, is biased by a 100,000-ohm resistor or by a 3,000-ohm resistor. The smaller of these may be put in shunt with the larger by means of a switch. When the switch is closed the actual bias resistance is slightly less than 3,000 ohms. The switch provides a means of changing the sensitivity of the set in one step, which is advantageous when changing from local to distant stations, and vice versa.

Each of the intermediate amplifiers, both 58s, is biased with a 150-ohm resistor in the cathode lead. The bias provided by these resistors is in addition to the automatic bias. There is also a fixed bias on the 2B7 pentode, for the grid is connected to ground through a 0.5-megohm resistor and the cathode is connected 150 ohms up from ground on the voltage divider, and a stopping condenser of 0.05 mfd. is connected between the grid and the slider of the potentiometer. The bias provided by the 150-ohm resistor is more nearly constant than if the resistor were placed in the cathode lead alone, because the current involved is more nearly steady.

The 56 audio amplifier is self-biased by a 2,500-ohm resistor in its cathode lead, and this is a satisfactory value when the load on the tube is a transformer. The output tubes, which are 2A3s, are biased by a 750-ohm resistor between ground and the center of the filament winding. The grids are returned to ground through

a 15,000-ohm resistor, shunted by a 2 mfd. condenser. The purpose of this resistor is to prevent excessive grid current during

A Universal

(Continued from preceding page)

that required for a broadcast tuner when the variable condenser has a maximum capacity about 350 mmfd. A broadcast coil, with a rather large primary, can therefore be used. A few turns may be removed from the tuned winding to bring about the proper coverage.

The 42.1 microhenry coil can easily be wound on a form one inch in diameter. Using No. 24 double silk wire, 53 turns are needed. The same number of turns may be used for the grid winding, preferably of enameled wire wound at the end of the tuned winding. The 8.34 microhenry winding may be made by winding 20 turns of No. 20 double silk wire on a one-inch form. Again the grid winding may contain the same number of turns and wound at the end of the tuned winding.

The smallest winding may contain 9 turns of No. 20 or heavier wire. As before, the grid winding should be like the tuned winding.

A very good dial should be attached to the variable condenser, for the calibration of the oscillator and subsequent reading can be no better than the dial.

Chokes

Choke Ch1 should be at least 85 millihenries and it should be made up of sev-

R 10-TUBE SUPER

ment, Thor Radio Co.

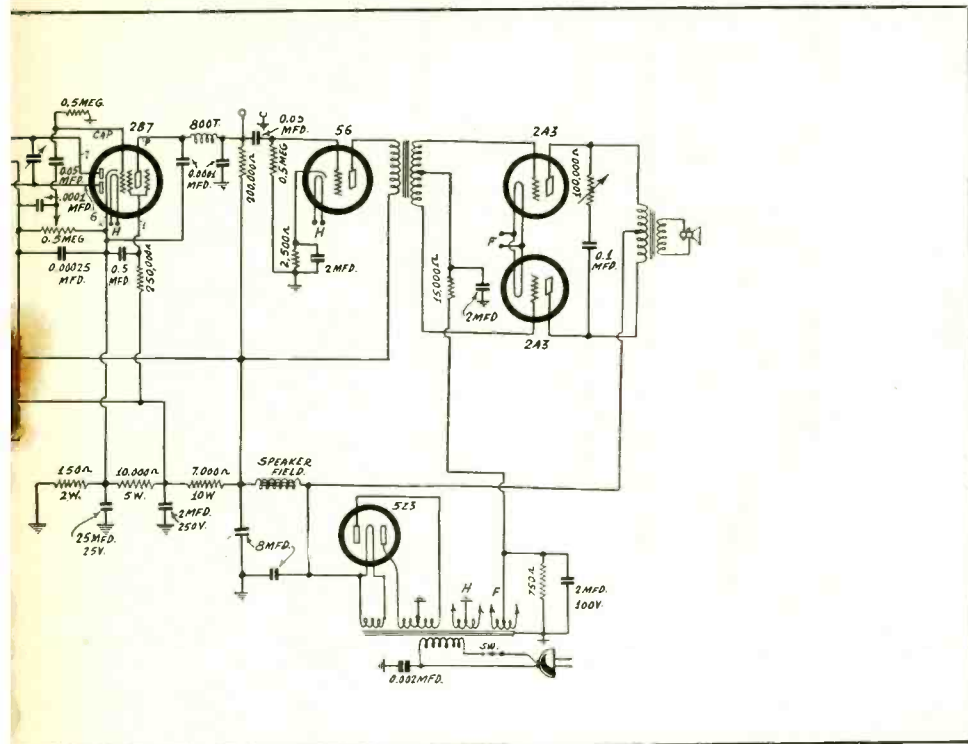

G. 1
dyne, a receiver of tremendous output and high sensitivity. Excellent a feature.

moments when the tube is overworked, which may occur during loud passages on low notes when the volume control is not

turned down sufficiently. It helps to clear up the quality on very strong signals.

Tone Control and Phono Jack

Provision is made of a phonograph jack or for phono terminals. The connection is made between ground and the top of the load resistance of the 2B7. It will be noticed that the connection leaves the bias on the 56 unchanged and therefore does not interfere with the amplifying property of this tube. That is as it should be. An alternative connection, however, is to tie one side of the phono pick-up to the grid of the 56 and the other to ground. This would not change the bias either. When the connections are made as shown in the drawing there is a slight current through the pick-up, but this is negligibly small due to the fact that the plate resistance, which is 200,000 ohms, is in series with it.

A tone control, consisting of a 100,000-ohm variable resistor in series with a 0.1 mfd. condenser, is connected across the primary of the push-pull output transformer. Its object, of course, is to give the set operator a chance to select his own quality by suppressing the high notes in comparison with the low.

Tremendous Output

In the plate circuit of the 2B7 pentode is a radio frequency filter consisting of an 800 turn choke coil in series with the line and two 0.0001 mfd. condensers in shunt, one condenser on each side of the choke. The main object of this section of low pass filter is to prevent radio frequency currents from going further in the audio frequency amplifier. It serves another purpose, however; it helps to suppress high

LIST OF PARTS

Coils

- One antenna coil, transformer type.
- One r-f coil, high gain type.
- One oscillator coil.
- Two 175 kc intermediate frequency transformers.
- One 175 kc intermediate transformer, secondary centertapped.
- One push-pull input transformer.
- One Pathfinder A. B. C. transformer.
- One Pathfinder r-f choke.

Condensers

- Two 0.5 mfd., 250-volt electrolytic condensers.
- One 8 mfd. electrolytic condenser, 600 volts.
- Three 2 mfd., 100-volt electrolytic condensers.
- Two 2 mfd., 250-volt electrolytic condensers.
- One 25 mfd., 25-volt electrolytic condenser.
- Two 0.05 mfd., 400-volt condensers.
- Five 0.1 mfd., 400-volt condensers.
- One 0.002 mfd. mica condenser.
- One 0.001 mfd. mica condenser.
- Two 0.00025 mfd. mica condensers.
- Three 0.0001 mfd. mica condensers.
- One 35 mmfd. equalizer condenser.
- One gang of three 0.00035 mfd. variable condensers.

Resistors

- One 100-ohm resistor, one watt.
- Two 150-ohm resistors, one watt.
- One 750-ohm resistor, one watt.
- One 2,500-ohm resistor, one watt.
- One 3,000-ohm resistor, one watt.
- Three 5,000-ohm resistors, one watt.
- One 10,000-ohm resistor, one watt.
- Two 15,000-ohm resistors, one watt.
- One 250,000-ohm resistor, one watt.
- One 40,000-ohm resistor, one watt.
- One 100,000-ohm resistor, one watt.
- Five one-half megohm resistors, one watt.
- One 200,000-ohm resistor, one watt.
- One 100,000-ohm variable resistor.
- One 0.5-megohm potentiometer, with switch attached.
- One 150-ohm resistor, 2 watts.
- One 750-ohm resistor, 5 watts.
- One 7,000-ohm resistor, 10 watts.
- One 10,000-ohm resistor, 5 watts.

Other Requirements

- Eleven sockets, three 4-prong, three 5-prong, four 6-prong, and one 7-prong.
- One Pathfinder chassis, drilled.
- One tuning dial, with numbers and kc.
- One pair of binding posts.
- One resistor mounting strip.
- Six shields.
- One single pole, double throw toggle switch.
- One phono jack, single circuit.
- One special speaker, 2,500-ohm field, with output transformer matched for 2A3 tubes.

l Oscillator

eral chokes in series. It should have a high inductance in order that it should not reduce the inductance L1 on the larger coils. It should have a low distributed capacity in order that it should not short-circuit the feedback current on the smallest coils. The capacity will be reduced by connecting coils in series.

The value of Ch2 is not so important. If it is 10 millihenries it is all right. This choke will have no effect on the frequency of oscillation and it is used only for coupling the amplifier to the output device, whatever that may be.

The filter choke is specified at 30 henries, but it is not important. It can be 100 henries or half a henry. Of course, if every trace of hum is to be removed, the choke should have a high inductance, but a little hum in the signal is of no consequence. At times it may be an advantage, for it amounts to a modulation on the radio frequency current generated.

The two condensers marked 4 mfd. may be of the electrolytic type. They may be larger or smaller if desired. The larger they are the less the hum will be, but, as was stated in connection with the choke, a little hum does not matter.

A 600-ohm bias resistor is used on the power tube and this is shunted by a 0.1 mfd. condenser. This capacity is large enough since it only serves to by-pass high frequency currents.

frequency noise which always appears in highly sensitive receivers when the amplification is increased.

The output of the receiver is tremendous due to the use of 2A3s in the output stage. The rated output is 7 watts when the distortion is limited to 5 per cent. This distortion is not appreciated by the most sensitive ear and considerably more out-

(Continued on page 20)

A HETERODYNE OSCILLATOR

Range from 0 to 250 kc, for
Audio and Intermediate Frequencies

By Herman Bernard

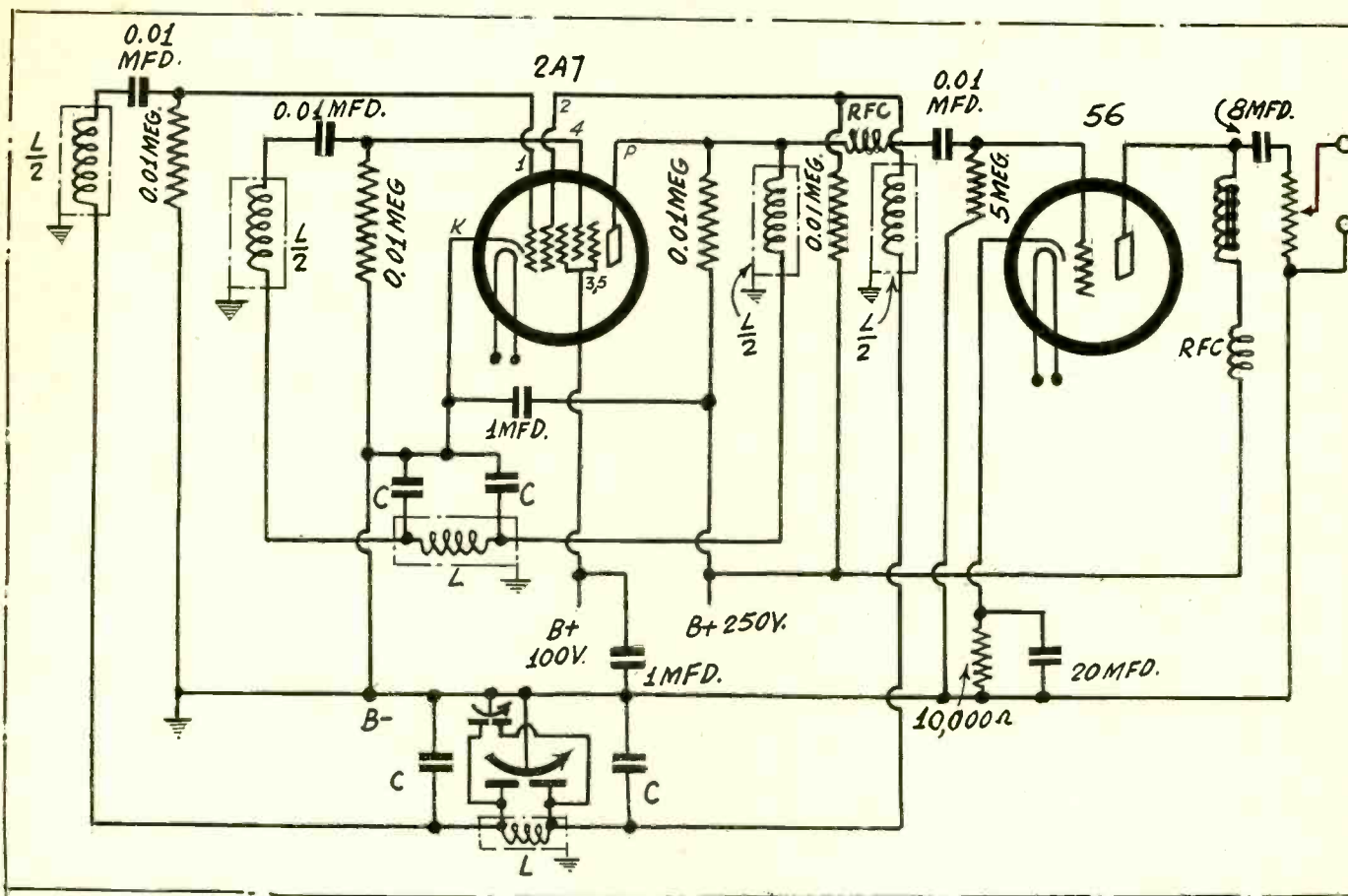

A HETERODYNE oscillator is the most satisfactory source of various wide-range frequencies within convenient attainment, since it is based merely on two oscillators, one generating a frequency differing from that of the other by the desired frequency.

One might take a random oscillator, duplicate it, couple one oscillator to the other, provide a detector output circuit, and actually get audio and radio frequencies. But such a contraption would have serious drawbacks. The frequencies of both oscillators would shift, hence the calibration would not hold. If one did not care particularly what the audio frequency was, and was content to judge approximately by ear (sometimes being only a few thousand cycles out of the way), the device would meet requirements. But if some accuracy is essential, then both oscillators should be frequency-stabilized.

Stabilized Oscillators

The diagrammed heterodyne oscillator is the Colpitts, with stabilizing reactances of the nature suggested by Llewellyn. The stabilizing reactances are inductances of half the value of the inductance tuned by the series condensers C. Thus L and L/2 are these inductances.

In the grid circuit is a low value leak, and in the plate circuit a resistor of the same value, following Llewellyn's principle, which is to make the effective impedances on grid and plate sides equal,

an assumption based on study of his circuit application.

The 2A7 tube is used, cathode being common, and providing the electron coupling of the two oscillators. Grid No. 1 is the control grid of the first oscillator, Grid No. 2 is the plate of the first oscillator, and thus the triode elements are utilized. The pentode is the other oscillator, where Grid No. 4 (overhead cap) is the control grid, Grids 3 and 5, tied together inside the tube, are the screen, and the plate is the plate from which the output is fed to the 56 detector tube.

The only reasons for the detector tube are to effectuate the resultant frequency capably and to interpose a useful high resistance between the test circuit and the work circuit, thereby to render variations of output loads and quantities ineffective upon the frequency of the test circuit. Since only audio frequencies and low radio frequencies are desired, a radio frequency choke coil is inserted ahead of the 56 tube. This is a choke coil of small inductance. The secondary of a regular broadcast coil would do, otherwise a honeycomb coil of around 200 to 300 microhenries inductance.

Fixed Frequency Selected

The first oscillator shows fixed condensers C and C only, in the tuned circuit, and this will be referred to as the fixed oscillator. The second oscillator shows, besides C and C, a dual condenser of adjustable capacity. This will be called the variable oscillator. It should be noted

that the variation in frequency may be from zero beat to highest frequency or from highest frequency to zero beat, depending on whether zero beat is established at maximum or minimum capacity of the variable.

With the circuit in mind, we have to select first the fixed frequency of oscillation, then the capacities and inductances to achieve this, then the equalization of the variable oscillator with the fixed oscillator on the basis of the variable dual condenser at maximum or minimum. Let us select the minimum and work from zero beat to greater difference (higher) frequencies. Increasing the capacity increases the frequency this time because increasing the difference.

The frequency of oscillation should be above the broadcast band, to get away from possible interference from harmonics of the radio frequencies, hence 3,000 kc was selected. If the inductance to capacity ratio is high, then the total capacity is small and the variable adjunct, or vernier capacity, is even a great deal smaller, so that we would run into impractical problems like variations of from 50 to 50.2 mmfd. So we select as low an inductance as is consistent with good oscillation, naturally to achieve as high a capacity as we may, whereupon the variable may be 15 mmfd., which is entirely reasonable.

A well-filtered power supply may be used for a-c operation, or batteries may be used to furnish both A and B power. For batteries the tubes might be the 6A7
(Continued on next page)

NON-REACTIVE AF

By William J. Bevin

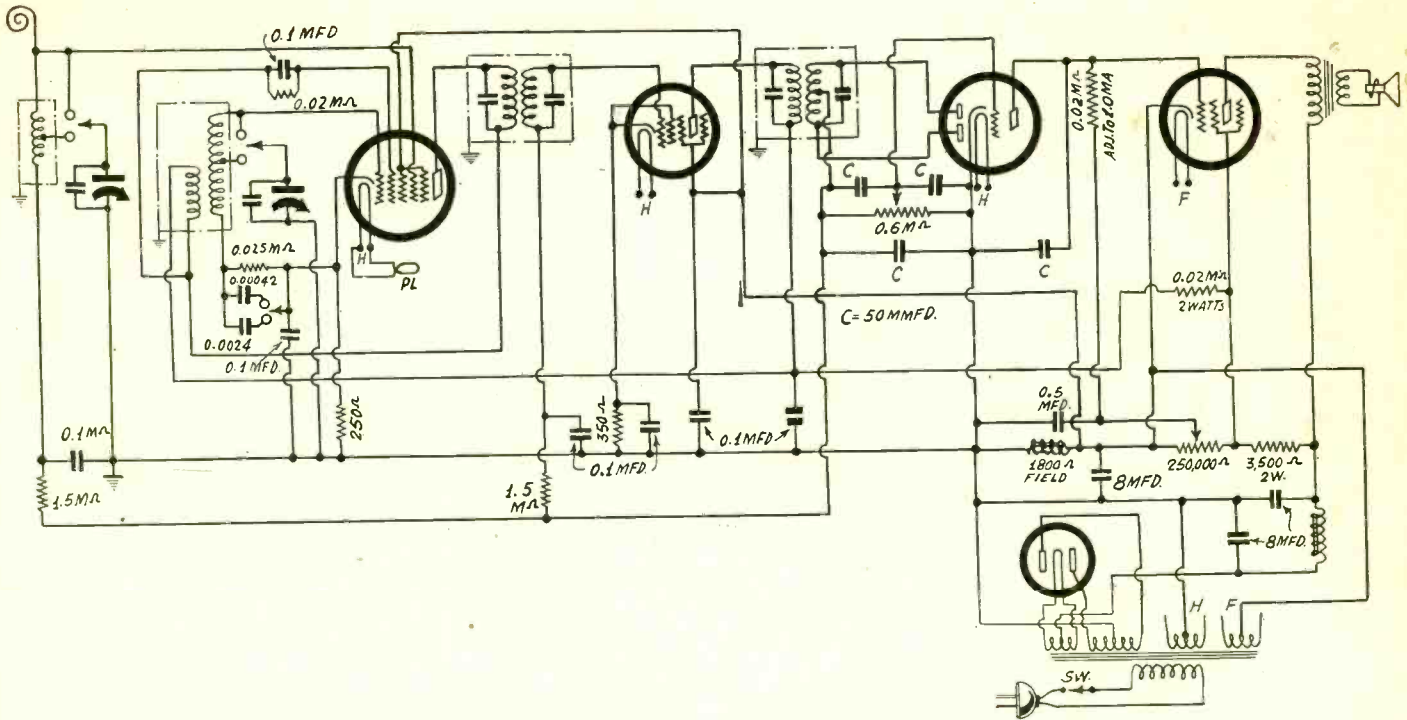

An experimental five-tube superheterodyne, using non-reactive audio. The first tube is a 2A7, so the mixer is electron-coupled.

THIS is a design for a 5-tube superheterodyne that should interest experimenters who favor the Loftin-White type of audio amplification. Since there is an abundance of B voltage from a power transformer secondary and rectifier, usually so that around 80 or 90 volts will be dropped in the field coil and not otherwise used, the series voltage method of the non-reactive audio amplifier may be adopted.

The circuit uses an impedance coil in the antenna circuit, and instead of an outdoor or other aerial, a 25-foot stretch of flexible wire is attached to one end of the antenna winding. This is all the aerial the receiver will stand. Instead of this method, a primary and secondary may be used, but the short stretch of aerial would still be the rule.

2A7 Tube Used

The 2A7 tube is used, the r-f input being

to the overhead cap (Grid No. 4), the total grids, left to right, being No. 1 (oscillator control); No. 2 (oscillator plate); Nos. 3 and 5 interconnected inside tube (screen); No. 4 (modulator control grid). The modulator plate and heater are standard. One circuit is coupled to another emissively, due to the common cathode.

So that police signals may be received the coils are tapped. For an intermediate frequency of 475 kc the data are: r-f winding, for 0.00041 mfd., 230 microhenries, tapped at 18th turn from ground end; oscillator, 126 microhenries, tapped at 16 turns from ground end. The padding capacities are shifted, hence a three-pole-double throw switch is used. The tuning condenser is a two-gang.

The intermediate amplifier is a 58, the second detector and first audio amplifier are a 55, the output tube is a 2A5, and the rectifier is an 80. Any suitable choke coil is

used for the main B filter, of a few hundred ohms d-c resistance, whereas the dynamic speaker field, 1,800 ohms or thereabouts, also chokes and aids as a voltage divider.

Adjusted to 20-Volt Bias

The theory of the voltage distribution is that from B minus it rises to plate voltage value for the 55, and the slider of a potentiometer is adjusted until, at no signal input, the voltage drop in the 20,000-ohm plate resistor of the 55 is equal approximately to the bias required for the 2A5. This is normally 16.5 volts, but a 20-volt bias is entirely satisfactory.

The oscillator is of the grid current type, the 25,000-ohm resistor being the grid leak, and the padding condenser in each instance the grid condenser.

This circuit is shown for the benefit of those desiring to experiment with non-reactive coupling, and has not been built.

Coils and Condensers for Oscillators

(Continued from preceding page)

and the 37, for which a 6-volt storage battery is suitable for A supply, while the B voltages may be 180 and 90 volts respectively, instead of the higher voltages shown on the diagram which are intended to apply to a-c operation.

The diagram shows the entire oscillator enclosed in a shield, but it is advisable to have not only the coils and tubes separately shielded, but to have a shield around one stage, another shield around the other stage, and a shield around the output circuit that consists of the audio choke coil, radio choke coil (as described), the 8 mfd. paper dielectric condenser, non-inductively wound, and the attenuator. This attenuator may have any value from 25,000 ohms up to a few hundred thousand ohms.

The audio choke should have a high inductance, which is easily attainable due to the small current in the plate circuit. It is recommended that the inductance be no less than 200 henries at 1 ma. In

series with the audio choke is another radio frequency choke, so that the r.f. that the audio choke would not force through the condenser would be forced through because of the choking action of the radio coil. The two radio frequency chokes had better be shielded, also.

Inductances and Capacities

C. is shown as a fixed condenser, and it is advisable that it be somewhat more accurate than the usual commercial run of condensers. This can be accomplished by using 5 per cent. accurate condensers. One circuit will operate at a slightly higher frequency than the other, due to natural discrepancies, and since the rotation is to be toward increased capacity, the higher frequency circuit would have the two-gang condenser across it. That is, after the frequency determination has been made, the higher fundamental frequency is established in the variable frequency

oscillator. It may be that zero beat will not occur at exactly minimum, and it is better that it should not, as then a little leeway is given for zero beat adjustment when the audio frequencies are to be used for testing.

The condenser C may be 390 mmfd., and as there are two such capacities in series, the effective would be 195 mmfd. Small deviation between one of series condenser and another would be of no particular importance, perhaps reducing an accuracy of 1 per cent. in the oscillator to 5 per cent. of 1 per cent. less, or an accuracy of 1.05 per cent.

To establish a frequency of 3,000 kc the inductance then would have to be 14.75 microhenries for L, and 7.375 for L-2. Thus L might consist of 33.5 turns of No. 18 enamel wire close-wound on a form 1 inch in diameter. As each coil is to be shielded, the inductance will be a little less than that, but no account need be taken for the inductance shrinkage due to shielding, because

(Continued on page 22)

Radio University

A QUESTION and Answer Department. Only questions from Radio University members are answered. Such membership is obtained by sending subscription order direct to RADIO WORLD for one year (52 issues) at \$6, without any other premium.

RADIO WORLD, 145 WEST 45th STREET, NEW YORK, N. Y.

Grounding Padding Condenser

WHEN the 2A7 and 6A7 are used as oscillators in superheterodynes the series padding condenser is placed on the high side of the tuning condenser. In other cases the padding condenser is placed between the coil and ground. Cannot this arrangement be used with the pentagrid oscillator tube as well? Will the change in the position of the padding condenser change the frequency so that it becomes necessary to change the coil? If so, how much is the change and should it be compensated with more or fewer turns?—W. H. C., New York, N. Y.

There is no appreciable change in the resonant frequency of the circuit and no compensation is necessary. It may require a slightly different setting of the padding and trimmer condensers, but the difference is so small that it will not be noticed. The reason the padding condenser is put on the high potential side of the tuning condenser is not that the frequency is different but that the circuit may not oscillate when the padding condenser is put between the coil and ground. If the circuit oscillates at all settings of the variable condenser when the padding condenser is put between the coil and ground, that is the best place for it, because then the padding can be adjusted without any body capacity effects. If the tickler winding is large enough and the voltages on the oscillator elements have the proper values, the circuit will oscillate.

* * *

Velocity of Radio Waves

DOES a radio wave on a transmission line travel at the speed of light the same as the wave does in free space? If not, what is its velocity and how much does it differ from the velocity of light?—E. R. W., Greenwich, Conn.

If there are no losses in the line, the velocity of the wave on the line is the same as the velocity of light, but if there are appreciable losses, the velocity is less. It is $1/(LC)^{1/2}$, in which L is the inductance and C the capacity of the line per unit length. It might be one per cent. less than the velocity of light in free space. The velocity of light through glass, for example, is less than that in free space.

* * *

Elimination of Audio Bands

HOW are the audio frequencies in certain bands eliminated from the output of a receiver in certain demonstrations to show the effect on quality of certain notes?—W. H. P., Atlanta, Ga.

If the low notes, say those below 200 cycles per second, are to be cut out, high pass filter is used, with the cut-off around 200 cycles. If enough filter sections of this type, all with the cut-off at the same frequency, are used, the lows will be eliminated almost completely. If the high frequencies are to be cut out, a low pass filter is used. As before, the more sections are used the greater will be the suppression of the highs. If a band in the middle is to be cut out, a band elimination is em-

ployed. It might be designed, for example, so that all frequencies between 200 and 400 cycles are cut out almost completely.

* * *

Tone Correction

IF the radio and intermediate frequency tuners discriminate excessively against the high audio frequencies, is it possible to compensate for the discrimination in the audio amplifier? If so, how can it be done?—R. E. W., Chicago, Ill.

It can be done and is done when necessary. An equalizer circuit that has the required characteristic is designed and put in the audio amplifier. In most cases it is unnecessary to compensate because exactly the opposite must be done to remove hiss and other high frequency noises. If audio frequency compensation were introduced to offset the effect of excessive selectivity, it would only be necessary to use more by-passing of the high frequencies.

* * *

Requirements of Band Filters

IF A TELEVISION receiver is to be constructed with a band pass filter that is to pass all modulation frequencies up to 50,000 cycles, how wide should the pass-band be in the intermediate and radio frequency selectors? Would it be a good scheme to put in a low pass filter in the audio frequency amplifier that will pass everything below 50,000 cycles and nothing above that frequency?—T. R. B., New York, N. Y.

The filter used in either the radio or the intermediate frequency selectors should pass a band 100,000 cycles wide, because it must pass both the higher and the lower sidebands. If, for example the intermediate frequency is 450 kc, the filter should pass all frequencies between 400 and 500 kc. If the r-f selector is to receive a single carrier frequency, a band pass filter can also be used in this level, but if it is to receive many carriers, the use of band pass filters is unpractical because it would be necessary to vary too many condensers. It certainly would do no harm if a low pass filter with a cut-off somewhat above 50,000 cycles were used in the audio amplifier. Just what good it would do is problematical. Perhaps it could be utilized as an equalizer.

* * *

Impedance of Tuned Transformer

WHEN a secondary-tuned circuit is used between two radio frequency amplifiers what is the impedance of the primary? Is it the inductive reactance of the primary winding? If it is, should not the winding be very large in order to put the required load on the plate circuit of a screen grid tube, like the 58, for example?—W. E. W., Boston, Mass.

What the effective impedance is depends largely on the secondary and on the coupling between the primary and secondary. The inductive reactance of the primary is only a small part of the total impedance, and the smaller that part the

better. The higher the selectivity of the secondary circuit the larger is the impedance of the primary, and also the closer the coupling between the two windings the greater is the impedance. The inductive reactance of the primary might be of the order of 100 ohms, yet the effective impedance may be as high as 100,000 ohms.

* * *

Why Class B Tube?

WHY are so many Class B put out when nobody uses them? What are the advantages of this method of amplification? I know many disadvantages.—S. R., Stamford, Conn.

Many use the Class B circuit. There are commercial radio receivers in which this method of amplification is used and there are many public address systems using it. Advantages of the system are that a much greater output is possible with small tubes than if the same tubes were used in Class A circuits and that plate current is drawn only when the tube is active, and only to the extent that it is active. The Class B amplifier is much more economical than the Class B.

* * *

Change of Inductance with Temperature

IN WHAT MANNER does the inductance of a coil vary with the temperature? Does it increase or decrease? What directly causes the change?—A. B. N., Des Moines, Iowa.

The physical dimension of inductance is a length. That is, the inductance may be expressed as so many centimeters. This indicates that the inductance varies as the length of the wire varies with temperature. That is, the inductance would increase as the temperature increases. By this it is not to be supposed that the inductance is measured by the length of the wire. However, suppose that the coil is wound with stiff wire on air. It is reasonable to assume that as the temperature increases, all the dimensions increase as the wire expands. To the extent that that is true the coefficient of change in inductance due to temperature is the same as the linear temperature coefficient of the copper wire. This is not very large.

* * *

High Frequency R-F Amplification

WHILE experimenting with high frequency amplifiers I have discovered that the more tubes and tuners the less the output. One tube with regeneration gives fine results. One regenerative tube and one r-f amplifier and two tuners give fair results, but more than that and the results are almost nil. Why is this? Why cannot radio frequency amplification be used on short wave receivers as well as on broadcast receivers? What causes the trouble?—J. M. B., Utica, N. Y.

There are many reasons. First, the circuit becomes so difficult to tune that it is next to impossible to find the combination that tunes the circuits at the same time. Second, interstage coupling produces regeneration that is not controllable, and as soon as the circuits approach resonance the receiver breaks into oscillation, and then all is off. Third, shunt capacities detour the signal to ground without giving the tuners a chance to build up high resonant voltages.

* * *

Accurate Coils

RECENTLY you published data on an oscillator in which the coil was supposed to be 253 microhenries because this coil would tune to 1,000,000 cycles with a condenser of 0.0001 mfd. I have tried determining the inductance several times and I get 253.3 microhenries. Which is cor-

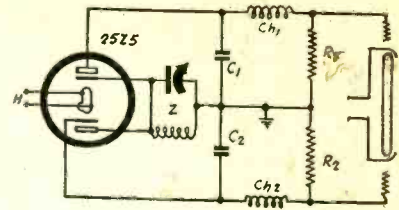
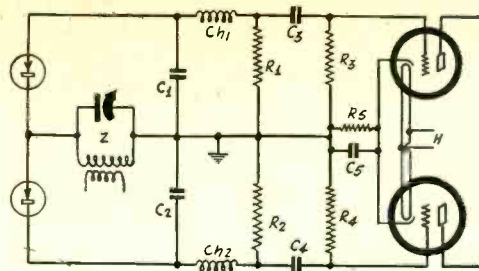
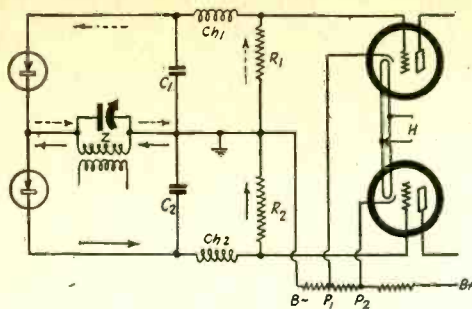

These circuits illustrate the principle and application of the voltage doubler. The principle is applied to detection and coupling to a push-pull amplifier.

rect? If 253.3 microhenries is the correct value and the inductance in the oscillator is 253 microhenries, what is the per cent. error in the frequency generated?—W. L. S., Kansas City, Kansas.

The correct inductance is $1/400\pi^2$ henries. If you work this out to the third decimal you get 253 and if you work it out to the fourth decimal you get 253.3. Neither is exactly correct but the second is nearer. The percentage error in the frequency is 0.06 per cent. If the oscillator is adjusted to one per cent. that would be all right for routine service.

Overmodulation

HOW is it possible to have over 100 per cent. modulation of a radio wave? Does not this mean that the variation in the radio frequency amplitude is greater than the amplitude itself? This seems to me to be a contradiction.—Y. T., Washington, D. C.

That is what it means but it is not necessarily a contradiction of terms. Of course, the wave is badly distorted under these conditions. Modulation means the mixing of two waves. There is nothing to prevent either of the two from being the greater.

Use of 55

WHEN the 55 tube is used as a driver of a Class B amplifier or when it is used as an ordinary audio frequency amplifier, what is done with the two diode plates? —T. R., New York, N. Y.

You don't do anything with them. Leave the lugs on the socket blank.

Class B for Broadcast Receiver

WOULD you recommend the use of a 53 in a Class B amplifier for a radio broadcast receiver? Is the improvement in tone and volume enough to offset the disadvantages of the system?—A. R. L., Marion, Ohio.

We do not recommend the Class B amplifier for broadcast reception. The output is many times greater than that needed in a home. Class A amplification gives excellent quality when the tubes are operated correctly and any of the regular Class A output tubes, in push-pull, will give more undistorted output than can comfortably be used in a home.

Diode Detection and Push-Pull

IS IT possible to couple a push-pull amplifier, tubes diode biased, to the output of a duplex diode triode or pentode? If not, why not?—J. W. C., Seattle, Wash.

It is not possible if the cathode of the detector tube is to be grounded, and it must be if the amplifier element is to be used for anything. If the cathode is grounded the amplifiers following will be in parallel as far as the audio signal voltage is concerned.

A Resonance Indicator

I HAVE a 0-100 thermocouple type gal-

vanometer. On the face of the dial it says that the current at full scale is 115 milliamperes. Is there any way of determining the current at any other deflection? If so, please explain. Can this instrument be used for taking resonance curves on coils? If it can, please explain.—W. R. B., Newark, N. J.

The deflection on this instrument is proportional to the square of the current flowing through it. That is, if D is the deflection and I the current, $D=kI^2$, in which k is the constant of proportionality. When the deflection is 100 the current is 115 milliamperes. Therefore the value of k is 0.00756, and the formula for determining the current at any deflection is $D=0.00756I^2$. This is more conveniently written $I=11.5(D)^{1/2}$. Therefore, if the deflection is 25, the current is 57.5 milliamperes, and if the deflection is 4, the current is 23 milliamperes. Resonance curves can be taken very easily with this instrument. Indeed, that is the main reason why it was made. To do it, it is not necessary to convert readings to milliamperes. Connect the meter in series with the tuned circuit of which the coil forms a part. Couple the output of a variable frequency oscillator loosely to the coil. Vary the frequency through resonance. Take deflections for various known frequencies and then plot the curve. Be very careful that the coupling is loose and that the oscillator does not oscillate too violently. If the circuit is very selective

the current at resonance will be so large that there is danger of burning out the thermocouple. Tune very slowly and watch the needle. If the maximum deflection is not near 100, increase the coupling to make it so. You can determine the selectivity factor of the circuit, which practically means of the coil, from the curve plotted from the deflections and the frequency. Find the frequency at which the deflection is one-half as great as it is at resonance. If f is this frequency and f_r is the frequency of resonance, then $Q=[f/(f-f_r)]^{1/2}$, in which Q is the selectivity factor. There are two possible values for this, depending on which way the circuit is detuned. Obtain both values for Q and take the mean as the selectivity factor of the circuit. Note carefully that this formula depends on using the frequency at which the deflection is one-half as great as it is at the resonance frequency.

Voltage Double for Detection

PLEASE show a circuit of 25Z5 in a voltage doubler circuit suitable for detection. I understand that this is possible and also that it is possible to couple this detector with resistance to a push-pull amplifier.—F. G. W., San Diego, Calif.

In the figure on this page are three such circuits, the first showing the principle and the other two different applications of it. In the middle circuit two separate tubes are used and in the last a 25Z5.

Join Radio World's

UNIVERSITY CLUB

And Get Free Question and Answer Service for the Coming 52 Weeks.

THIS SERVICE FOR UNIVERSITY SUBSCRIBERS ONLY

Subscribe for RADIO WORLD for one year (52 numbers). Use the coupon below or write on a separate sheet of paper, if preferred. Your name will be entered on our subscription and University Club lists by special number and you will be apprised of the number. When sending questions, put this number on the outside of the forwarding envelope (not the enclosed return envelope) and also put it at the head of your query. If already a subscriber, send \$6 for renewal from close of present subscription and your name will be entered in Radio University.

NO OTHER PREMIUM GIVEN WITH THIS OFFER

[In sending in your queries to the University Department, please paragraph and number them. Write on one side of sheet only. Always give your University Club Number.]

RADIO WORLD, 145 West 45th Street, New York City.

Enclosed find \$6.00 for Radio World for one year (52 nos.) and also enter my name on the list of members of RADIO WORLD'S UNIVERSITY CLUB, which gives me free answers to radio queries for 52 ensuing weeks, and send me my number indicating membership.

Name

Street

City and State

LIGHT OF STAR TO OPEN FAIR; EVENT ON AIR

Chicago.

Across 240 trillion miles of space, radio listeners will "hear" a star when Arcturus sends the impulse that will light A Century of Progress and officially open the Chicago World's Fair of 1933 on Saturday, May 27th. The beam of light, which left Arcturus during the Columbian Exposition 40 years ago, will be broadcast over an NBC network as a tone beat of increasing volume as the current is transmitted from astronomical observatories in different sections of the country.

The National Broadcasting Company has launched plans to bring to the radio audience details of the opening of the fair, as well as of the major events of importance throughout the summer.

Roosevelt to Speak

Lighting of the grounds will climax the activities of the opening day following an elaborate program in the Court of Honor, before the Hall of Science. Speakers will include President Roosevelt, Governor Henry Horner of Illinois, Mayor Edward J. Kelly of Chicago, Rufus C. Dawes, president of A Century of Progress, and representatives of foreign powers.

The Chicago Symphony orchestra, under the direction of Dr. Frederick Stock; Lawrence Tibbett, baritone of the Metropolitan Opera Company, and a chorus of 2,000 voices will furnish the musical portion of the evening ceremony. It is expected that this will be broadcast at 9:00 p. m., EDST.

At a signal from the announcer, Harlow Shapley, director of the Harvard Observatory, will open a telescope so that the light from Arcturus is focused upon a photo-electric tube. This tube transforms the light to energy, which will be amplified and transmitted over wires to A Century of Progress grounds, where it will close one opening of a series circuit leading to a master switch.

Lighting Ceremony

It also will light a neon sign on a map of the United States, which will show that the impulse has been received from Cambridge and will set in motion a 500-cycle motor generator that will give an audible signal to the radio audience.

As each of several observatories throughout the United States is tallied the same process will be repeated, and with each new impulse the speed of the motor generator will be increased to give a shriller tone. When the final signal is received the fourth circuit will close, the master switch will be thrown and the searchlight on the tower of the Science building lighted.

When this beam of light sweeps the Exposition ground photo-electric cells on the various buildings will turn on the dazzling exterior illumination of the buildings until the grounds are bathed in gorgeous multi-colored lights. The lighting ceremony is expected to occupy about 15 minutes.

SINGER DESIGNS DRESSES

Arlene Jackson, NBC singer, does not limit her honors to those gained in radio. Before coming to the air she won several awards in dress design, and still pursues the art as a serious hobby. Her favorite time for sketching is when she awakens, usually around noon.

Wired Symphony Proves Its Range

Wired transmission of music and electrical control were demonstrated recently to an invited audience of Philadelphia Orchestra subscribers and guests of the American Telephone and Telegraph Company by Leopold Stowkowski, leader of the Philadelphia orchestra, and Dr. Harvey Fletcher, of the Bell Telephone Laboratories. The orchestra played Bach's "Tocatta and Fugue in D Minor," The Fifth Symphony of Beethoven, Debussy's "L'Après-midi d'un Faune," and the finale of "Gotterdammerung," music especially selected to show the tremendous range and force of the new system.

The music was conducted from the orchestra to the concert hall by three wires to as many speakers.

AMATEURS AID "STRATO" FLIER

Hartford, Conn.

Radio tests preparatory to a third ascent into the stratosphere from Belgium, to be attempted in July by Max Cosyns, Prof. Piccard's assistant in the previous two flights, are now being conducted through arrangements with the Reseau Belge, national Belgian amateur society, and the American Radio Relay League.

Centering largely on the aeronautical aspects, the tests will be conducted for the most part from a flying installation in a Bush-Moth Gypsy 'plane, being operated by Jacques Mahieu, of "Le Manoir," Peruwelz, with the call letters XXON4AU. Regular tests are scheduled for Thursdays and Sundays during May and June between 15.00 and 18.00 GST, or 10 a. m. and 1 p. m., EDST.

The frequencies to be used in these tests are 7,300 and 14,000 kilocycles, according to F. E. Handy, communications manager of the American Radio Relay League, who has promised M. Cosyns and M. Mahieu the full cooperation of his organization. The transmitter will be powered at 25 watts on code, and 40 watts on voice.

Special equipment will be evolved from these experiments to be used on the craft developed for the stratosphere ascent in July, which will probably be operated by Max Cosyns, the brilliant young physicist. He manipulated the radio apparatus used on the previous two ascents, led by Prof. Piccard, and in which he had the cooperation of radio amateurs throughout Europe and the rest of the world. An ardent radio amateur himself and member of the board of Reseau Belge, he assures radio activities a prominent place in the scientific investigations to be made during the third Belgian ascent into the stratosphere.

Radiomarine Closes Largest Ship Order

Charles J. Pannill, executive vice-president of the Radiomarine Corporation of America, announced the award to that company of a contract for radio service on the 67 ships of the Lykes Brothers combined steamship interests. Twenty-five of the vessels will be equipped immediately with Radiomarine emergency transmitters and complete, standard equipment is being purchased for seven.

"This order for radio service and apparatus is the largest ever placed by an American steamship organization," Mr. Pannill said.

BRITISH PREFER WAIT BETWEEN THE PROGRAMS

A radio audience composed of thousands, which writes "a letter now and then" to the radio station, telephones "perhaps three or four times a day" and utters its most active complaint when one program follows another too closely, without a wait of three minutes—that's the one to which British microphone artists play.

"Eighteen thousand telephone calls—and all for one program—how strange!" breathed Malcolm Frost, British Broadcasting Corporation executive who visited NBC's San Francisco headquarters today on his way to the ship which will take him around the world.

"British audiences don't take nearly so active an interest in programs as you do over here," Frost said. "Our only check on their reaction is what is printed in the press.

"We don't work on such a close time schedule as you do over here, either. When a program of national importance is ready to be presented, we call all the other stations—Edinburgh and so on—they say, 'Ready' and when they have all responded, the program goes on. American audiences don't like to wait for programs? British listeners insist upon a few moments' interval; they declare they enjoy what they hear all the more if it doesn't follow too closely upon the program which has preceded it."

Frost's visit to America is in the capacity of liaison officer between the British Broadcasting Corporation and radio stations elsewhere, looking toward international broadcasts, he said. He visited Canadian broadcasting stations on his trip across the continent, and will visit British stations in Australia, New Zealand, Ceylon, and other far spots on a globe-circling journey back to England.

Amateurs' License Manual Gives Procedure Plainly

In Number 9 of the Radio Amateur's Library, every detail of the complex procedure of obtaining, renewing and modifying amateur licenses for station and operator is set forth understandably and clearly. In its twenty pages are to be found the rules of procedure governing every aspect of amateur license-getting. But more than that, it contains a technical compendium supplying the knowledge requisite in passing the operator's examination, as well as a pertinent digest giving the necessary details of national and international radio law and the regulations of the Federal Radio Commission—all in the form of questions and answers which may be asked in the license examinations.

Written by the American Radio Relay League headquarters staff, it is in amateur language, understandable and reliable. All classes of amateur licenses are covered, from the temporary license with its mail examination through the unlimited radio-telephone certification, the specialized knowledge required for this being covered in a separate 'phone section, and finally the extra-first class license.

PHILCO SALES AHEAD

J. M. Skinner, president of Philco Radio and Television Corporation, says that Philco home radio sales beat any previous April in Philco's history.

STATION SPARKS

By Alice Remsen

The Show Boat (For the MAXWELL HOUSE PROGRAM)

WEAF, Thursdays, 9:00 P.M., EDST

Paddle wheels a-churnin' on the ol'
Miss'sip'
Hurriin' to make the landin' soon.
Got to get to Friar's Point on this here
trip,
A'fore we see the balance o' the moon.

Folks are waitin' anxiously fur this ol'
boat,
Been doin' it fur twenty years or more;
Make it every season as long as we're
afloat,
We're always plyin' up an' down the shore.

Got a dandy show, folks, best we've ever
had.
Ol' calliope is goin' strong.
All the actors double brass, some ain't bad,
Got a gal that sure can sing a song.

Open with a minstrel show, close with a
play,
A drama to bring tears into your eyes.
Sure to get your money's worth, so it will
pay,
We aim to satisfy each one as buys.

Music, song, an' laughter, lots o' funny
jokes,
We got the most stupendous show afloat.
Can't afford to disappoint the many folks
A-waitin' fur the marvelous Show Boat.

An' so we'll have to hurry down the ol'
Miss'sip',
While ol' calliope whoops out a tune—
Steam her up fur all she's worth on this
here trip
To Friar's Point—an' make the landin'
soon.

—A. R.

* * *

If you like the local color and atmosphere of show boat life, be sure to tune in on Captain Henry's Maxwell House Show Boat. You'll hear some mighty fine singing by Lanny Ross, Annette Hanshaw, and Muriel Wilson; a lot of good black-face comedy by Molasses and January; the cheery personality of Charles Winninger, plus the Showboat band of Don Voorhees. A very pleasant program with which to while away an hour at home.

* * *

THE RADIO RIALTO

THOSE SUMMER CHANGES

From all appearances the studios around here are slacking down for the summer. Advertising ballyhoos will reach a low minimum. Lucky Strike will take its Magic Carpet off the air after June 29th, retiring into oblivion the biggest cigarette account after an uninterrupted run of nearly five years. Plenty of experiments are under way for the summer; new talent will be tried out, new ways of broadcasting old programs shown, schedules will be shifted. Program directors will wrinkle their foreheads in an endeavor to figure out THE perfect program. . . . At WABC the John Henry series will be split up into two-a-week. . . . There will be a series of dramatic programs built from classic short stories featuring Poe

and De Maupassant. . . . Many new sustaining programs will be designed to fill out ex-commercial spots. There are always shakeups at these periods, old people let out and new people hired. . . .

MORTON DOWNEY AND THE BREWERS

Out in San Francisco Morton Downey is talking to some big beer barons as to a program for the Fall; the canny Morton is willing to be paid off in brewery shares; at his rate of salary it wouldn't be long before the boy would own the brewery. . . . Rudy Vallee recovered okay from his nose operation; I heard him sing on Thursday and he sounded just the same to me—but, good gracious, Rudy wouldn't be Rudy without that little nasal touch. . . . Agnes Moorhead is coming into her own; she has been signed by Irwin Cobb as his lady stooge on the new Columbia series for the Gulf Refining Company. They'll be on NBC also with Will Rogers. The law of average takes care of things after all. The cigarette accounts fade and the oil programs come in. So there you are! . . . The Gold Dust program, featuring Goldy and Dusty with the Silver Dust Twins, has been renewed. This program has been on for some time, heard over ten Eastern Stations on a Columbia hook-up without coming over WABC; now, however, it is also heard over the New York outlet. . . . I may have an interesting announcement to make to you anent this program next week; anyhow, in the meantime, listen in over the following stations at 9:15 a.m. EDST, each week-day morning except Saturday: WOKO, Albany, N. Y.; WGR and WKBW, Buffalo, N. Y.; WHP, Harrisburg, Pa.; WDRC, Hartford, Conn.; WCAU, Philadelphia; WHAS, Pittsburgh; WHEC, Rochester, N. Y.; WFBL, Syracuse, N. Y.; WWVA, Wheeling, W. Va.; WORC, Worcester, Mass., and WABC, New York. . . . The Columbia Broadcasting System announces that it will carry the full schedule of thirty Sunday afternoon concerts by the New York Philharmonic Symphony Orchestra for the 1933-34 season. Bruno Walter, distinguished German maestro, will direct the first part of the season, and Arturo Toscanini, General Musical Director, will return for his ninth consecutive year to conduct the second part, with Hans Lange on the podium for the intervening concerts. The series of six concerts for children and young people, directed by Ernest Schelling, will be broadcast on Saturday mornings. The Sunday Philharmonic concerts will be broadcast from Carnegie Hall, New York, from October 8th to April 29th. . . .

DE CORDOBA ON DECK

Pedro De Cordoba, the "Friendly Philosopher," with Will Osborne's Orchestra, has changed to a summer schedule and is now heard over CBS stations in New York, Buffalo, Boston and Providence at 10:45 a.m. EDST, and is broadcast over other stations of the Columbia network at 11:45 a.m. EDST. . . . Howard Barlow's Columbia Symphony Orchestra programs are now heard from 10:45 to 11:15 p.m., EDST, Mondays, Tuesdays, and Thursdays, while Nino Martini's recitals are presented on Mondays, from 8:15 to 8:45 p.m., EDST, and on Fridays from 8:00 to 8:30 p.m., EDST. If you've not yet heard Nino Martini, by all means don't miss him; he is marvelous, THE tenor of the season. . . . It took five different Columbia artists to replace Myrt and Marge in their star spot at 7:00 p.m. Here's the

line-up: Mondays, Theo Karle, operatic and concert tenor; Tuesdays, Gypsy Nina, singer and accordionist; Wednesdays, tenor Charles Carlile; Thursdays, the Street Singer; Fridays, Little Jack Little. . . . Too many male singers on the list; there'll probably be a shift before the summer's over. . . . Over at NBC Billy Jones and Ernie Hare are scheduled to go back on the air. By the time this is in print they already will have made their initial bow after almost a year of air-silence. They claim to have a new idea; if you doubt it, well—just listen in to these old-timers on Wednesdays at 8:30 p.m., EDST, over WJZ and network. . . . A new program, "The Old Skipper," began its career over WJZ May 14th. Written by H. Emerson York, it can boast of Marion Green as "The Old Skipper." . . . Ralph Kirby, the Dream Singer, will still continue on his sustaining period; it is rumored that a certain well-known New York columnist is partly responsible for Ralph's retention. . . .

ED WYNN FOR ALL SUMMER

Ed Wynn will stay on the air all summer, with his option taken up for twenty-six more weeks. This is good news for the laughter-lovers. Wynn's merry chuckle would be sorely missed. . . . The Campana Corporation has renewed its First Nighter series for another year. This program emanates from the Chicago studios of NBC, and may be heard over WJZ and network each Friday at 9:00 p.m. EDST. June Meredith, Don Amache, Carlton Brickert and Cliff Soubier, with Eric Sagerquist's orchestra, are featured in this broadcast. . . . Al Goodman and his well-known band are again a part of the Will Rogers performance over WJZ and network at 9:00 p.m. each Sunday. Al has been with Will from the "Follies" to radio, and guess he always will be if the will of Will is consulted. . . . Nancy Turner, who broadcasts the styles from the Pimlico track during the Preakness, is WBAL's own stylist. Nancy is a swell looking gal and can certainly wear clothes. She is one of the leading fashion authorities in the East. She was doing fashion advertising in Baltimore when she joined the staff of WBAL. Her dynamic personality may be heard from the Baltimore studios of WBAL, every Monday, Wednesday and Friday morning at 9:30 EST. . . . Lowell Thomas, who is a member of Sigma Delta Chi, was honored recently at Bucknell University, Lewisburg, Pa., when he was made an honorary life member of Pi Delta Epsilon.

* * *

ANSWERS TO CORRESPONDENTS

John E. Soltsick, Pittsburgh, Pa. . . . Shall send along the information requested as soon as it is obtained.

R. S. Roberts, Hornell, N. Y. . . . Thanks for your kind words. Am not on the air at present but expect to be in the near future and shall notify you. . . . Peter Dixon is on WOR with his Raising Junior program. . . . Watch local papers for schedule; if not printed I'll send it to you.

* * *

Biographical Brevities

ABOUT JACK BENNY

This famous comedian of stage and radio was born in Waukegan, Illinois, on February 14th, 1894. . . . Benny was not his family name; he's forgotten how to spell that. His parents still reside in Waukegan, the population of which is now over twenty-five thousand. Jack resided there for twenty years and watched it grow; he feels quite proud of the old home town.

Jack started to play the violin when he was six years old, and how he loved to play. In fact, he was expelled from high school when the faculty discovered him

(Continued on next page)

PERSONALITIES Station Sparks

Jessica Dragonette, NBC soprano, returned to her alma mater, Georgian Court College, Lakewood, N. J., to sing in the annual Spring Music Festival. Each year Miss Dragonette is invited by the convent sisters to return for the festival in which she took leading parts during her school and college days. The young singer entered the convent school at the age of six years and remained there until she was graduated with a B.A. degree. There she first learned to sing and to play the piano under the tutelage of the sisters.

* * *

The first money that Lowell Patton, organist, ever made was earned as organist of the Pilgrim Congregational Church, of Portland, Ore., his home town. Patton says he bought a piano with the weekly stipend.

* * *

Verlye Mills, twenty-year-old harpist heard over NBC networks with Harry Reser, has been playing the harp since she was nine. She was a prodigy at 13 and appeared as soloist with the Chicago Symphony.

* * *

Irene Franklin is now on the air. She is heard in a semiweekly series of song programs each Wednesday and Friday evening at 10:15 p. m., EDST, over an NBC-WJZ hook-up.

* * *

Those "bells" which Joe Green, xylophonist, plays on his program over NBC networks, are really bars of glass laid on a xylophone rack. They have tones distinctive from the usual wood blocks of the xylophone.

* * *

When Jimmy Kemper, the "Blue Jay Song Man," was playing in theatres in Australia during a world tour he found that the "Aussies" were more familiar with American songs than were most audiences in the United States.

* * *

Mary Steele, contralto heard regularly on four network programs from Chicago, earned her first money by singing at a funeral when she was 14 years old. She began giving concerts in small towns about Kentucky when she was 16.

* * *

Harold Stokes, Chicago orchestra director, has turned "Don Quixote," with the difference that he is fighting for his windmill. A dispute arose as to whether a windmill is on his Hillsboro, Illinois, farm or on the neighbor's, and he is having the property surveyed.

* * *

It's a long way from New York to Ketchikan, but there's a woman in that Alaskan town who listens in regularly to an NBC program each Tuesday night.

Lowell Patton, organist on the Mid-Week Hymn Sing, broadcast from New York over NBC networks, has had a letter from the Ketchikan woman, who reports that the weekly program is clearly heard in the far north through Pacific coast stations of the network.

The writer also stated that she was one of Patton's former music pupils in Portland, Oregon, the organist's home town.

* * *

Harold Stern, whose orchestra is heard over networks from the Hotel Biltmore in New York, has a library of military music insured for \$35,000.

* * *

When Borrah Minevitch and his Rascals broadcast over NBC networks, they use no music. They mount the lyrics to the song on a music stand, and follow the words.

* * *

Often the thin air that radio characters

are made of is much closer to flesh and blood than the listeners realize. The radio writer frequently chooses not only the name of a real person but places him in his proper niche in life.

For instance Uncle Virgil, who recently made his appearance in the Northwestern Chronicle program over NBC as the uncle of Rhiney Masters from East St. Louis, was almost one of these. In writing the program, Paul Rhymer used the name of Uncle Virgil simply because it fitted the program. When Merrill Fugit, who plays the part of Rhiney, read the script he stopped in surprise.

"How did you know I had an Uncle Virgil?" he asked. "You've got him down from the wrong town. He lives in Kansas City."

Some time ago when Ernest Kreuger was planning a campaign for mayor of Chicago in the Clara, Lu 'n' Em program, Clara happened to remark on some experience of her Uncle August when he was mayor of Piper City. Within a few days letters arrived from Piper City, Ill., asking if Clara actually was a niece of August Opperman, who was mayor there for several terms.

10-TUBE SUPER

(Continued from page 13)

put could be obtained before the distortion is noticeable. However, such tremendous output will not be tolerated in a home, as a rule. Most of the time the output will be adjusted to a considerably lower level, and that means that the distortion will probably not amount to more than one per cent. That is the main object of using such output tubes, the removal of the last trace of distortion as far as practicable. The rated output and distortion are based on a single tube. In a push-pull stage the distortion is much less. Therefore, we may say that the output is entirely distortionless whenever the set is operated with any power level likely to be tolerated in a home, or even in a small hall, if the set should be used to provide dance music or for the purpose of addressing an assembly. It will be recalled that the full power will only be called into play on the very lowest tones. Rarely are such tones contained in the signal, but when they are, the circuit has the necessary reserve to support them.

The B Supply

The full output of the 2A3 will not be possible unless there is an ample supply of plate current from the B supply, with large reserve tank condensers. The Pathfinder is amply powered with a B supply, utilizing a 5Z3 rectifier. An adequate power transformer stands between this tube and the power line. This transformer has one 5-volt filament winding for the rectifier. This is not centertapped as centertapping is entirely unnecessary. It has two filament windings of 2.5 volts each, both centertapped. One of these windings is used exclusively for the 2A3 tubes and the other for the heaters of all the other tubes requiring 2.5 volts. The center of the winding serving the heater tubes is grounded to remove the possibility of hum. The center of the winding serving the two 2A3 tubes is grounded through the bias resistance and the condenser across it.

The plate return of the push-pull amplifier is connected directly to the filament of the rectifier so that there is no other filtering than that provided by the 8 mfd. condenser next to the rectifier. This is adequate for a push-pull stage

(Continued from preceding page) sneaking out to play jobs with orchestras. First went into vaudeville as a violinist with a piano player. The act was known as Benny and Wood. Joined the Navy during the Big War. Toured the country with the Navy show for the benefit of the Seaman's Fund; managed to acquire the leading comedy role. When he returned to vaudeville he developed the comedy end of his act so that the fiddle soon became just an added attraction.

Jack's great success on Broadway landed him on the Coast, where he met "Mary"—later, he happened on her again in Chicago, took her out, fell in love, married and up to now has lived happy ever after. He played for the Shuberts in "Great Temptations." Opened the Orpheum Theatre, Los Angeles, as master-of-ceremonies. Was engaged by M.G.M. and appeared in a great many of their pictures. Then he was starred in Earl Carroll's "Vanities." Played an engagement in England and liked it; thinks the English really have a sense of humor; he's my pal. Clicked on radio from the start and has probably only just started. He and Mary are an ideal couple. Her real name is Sadie. Don't be surprised to find Jack Benny on a very important program this Fall.

when full-wave rectification is employed. It has the advantage that the voltage regulation is better in that the plate current does not have to flow through the resistance of a choke. The condenser supplies unusual draughts of current on low notes without any fall in the voltage.

The field of the loudspeaker is used for filter choke for all the tubes in the circuit except the power tubes. Since this field has a high inductance and also since it is not saturated by excessive current, it is very effective in removing hum. Its resistance is 2,500 ohms and is wound so that the strength of the field has the proper value when the plate and screen currents and the bleeder current flow through it. Naturally, there is a drop in voltage in the field but the transformer gives a voltage higher than is needed by the tubes other than those in the power stage. As a further aid in the filtering of the supply to the tubes a second 8 mfd. condenser is connected between the junction of all the plate returns and ground.

The voltage to the screens is dropped from the high voltage by a 7,000-ohm resistor. For bleeder a 10,000-ohm resistor is used. This is augmented slightly by a 150-ohm resistor which is used for bias on the 2B7. The voltage is divided, approximately, so that the screens get 100 and the plate 200 volts. Those are the values when the set is adjusted to maximum sensitivity.

Tuners

The three intermediate frequency transformers are doubly tuned at 175 kc. Of course, they are shielded, and they are all alike, with the exception of the third, which has a centertapped secondary.

Between the antenna and the first tube is a regular antenna tuning coil, of the transformer type. Between the first tube and the modulator is a high gain coupler, which in effect is a choke-condenser-tuned impedance coupler. Its advantage is that it is more effective on the low broadcast frequencies than a straight transformer would be. This increased effectiveness is due to the fact that the choke and the plate-cathode capacity of the tube forms a parallel tuned circuit at some low frequency either in the band or just outside.

Special 30 Tube for Short-Wave Work

A new Triad tube is offered to experimenters, designers and amateurs for short and ultra-short-wave equipment.

Suggested by A. Binneweg, Jr., of San Francisco, this new type 30 Special has been introduced for those interested in short-wave reception and transmission. The company states:

"Losses due to a radio tube, especially at high frequencies, are considerable. Unless these losses are considered in the design of the tube, the efficiency at these frequencies will be very poor.

"Most of these losses occur because of close spacing of wires in the glass stem. Through wider spacing, together with bringing the plate lead out of the top of the bulb, the inter-electrode capacity of the new T-30 Special has been considerably reduced.

"These 30's were actually used in a well-known tuned-plate, tuned-grid 5 meter transmitter, that normally required the use of two 71-A's. With slight changes in the grid coil and filament voltage, it was made to oscillate at an even higher frequency than was possible with the 71-A's! Tentative tests proved that the tube was much more efficient at these wavelengths than any other of its type. With less power input these special tubes produced just as strong a signal over a three mile distance as the 71-A's did, with a greater power input.

"Not content with this performance, Triad Engineers desired to see just how far they could reach out. A CQ call on the 5 meter band brought forth an answer from a city located 25 miles away.

"Tests on these new special 30's have proven that the tube is much more efficient at short wave lengths than the regular 230."

THE NEW 75 TUBE DUPLEX-DIODE TRIODE (High-Mu Triode) TENTATIVE RATING AND CHARACTERISTICS

Heater Voltage (A. C. or D. C.)...6.3 Volts
Heater Current.....0.3 Ampere
Direct Interelectrode Capacitances—Triode Unit (approx.):

Grid to Cathode.....1.7 $\mu\text{mf.}$
Grid to Plate.....1.7 $\mu\text{mf.}$
Plate to Cathode.....3.8 $\mu\text{mf.}$
Overall Length.....4-9/32" to 4-17/32"
Maximum Diameter.....1-9/16"
BulbST-12
CapSmall Metal
Base (For connections, see Note 1)
Small 6-Pin

TRIODE UNIT (Class A Amplifier)

Operating Conditions and Characteristics:

Heater Voltage6.3 Volts
Plate Voltage.....250 max. Volts
Grid Voltage.....—2 Volts
Amplification Factor.....100
Plate Resistance.....91000 Ohms
Mutual Conductance.....1100 Micromhos
Plate Current.....0.8 Milliampere

DIODE UNITS

Two diode plates are placed around a cathode, the sleeve of which is common to the triode unit. Each diode plate has its own base pin.

Note 1:

Pin 1—Diode Plate
Pin 2—Triode Plate
Pin 3—Heater
Pin 4—Heater
Pin 5—Cathode
Pin 6—Diode Plate
Cap—Grid

Pin numbers are according to RMA Standards.

Note 2: Resistance coupling is recommended for output circuit of the triode unit. The value of resistor suitable for 250-volt plate supply is 0.1 megohm.

TRADIOGRAMS

By J. Murray Barron

A new superheterodyne kit, a ten-tube circuit, using all that is the finest and newest in the industry, is announced. Just a few features include the 2B7 and the 2A3 tubes, with push-pull for the 2A3's, also automatic volume control and 10 kc selectivity. It's the finest thing in kit form put out in New York in some time and in reality better because it incorporates the best by test. Thor's Bargain Basement is back of this product, which is the result of experience with other successful kits, still in big demand.

* * *

El Rey Radio Mfg. Co., of Los Angeles, Cal., announces a summer line of automobile radios, among the smallest receivers of their type. While the design is small and handy, yet standard parts are used.

* * *

Fada Radio & Electric Corporation find from an analysis of the export business that the world in general wants quality merchandise. The percentage of higher-priced sets sold abroad is greater than that in the domestic market, says Philip Valk, director of exports for the company. This thought should apply to others seeking this class of trade if they expect to get repeat orders.

* * *

E. E. Griffin, for the past three years chief engineer for the Universal Microphone Co., Inglewood, Calif., has been made a vice-president of the organization. He will continue in charge of the technical and the precision laboratory.

* * *

It is announced by the Postal Radio Corp., 135 Liberty St., New York City, that the demand for the small ac-dc-type radio receiver for use in the automobile is still great and only exceeded by the demand for the Postal B Eliminator. This unit is used for other type radio receivers than the small one, for instance, in many places and for many purposes when a B supply is required. There are simple instructions and pictorial diagrams for those really interested in getting an efficient and inexpensive unit. Notwithstanding the demand, there is still production sufficient to take care of all demand for the next few weeks.

Ten Years Ago!

(Some of the features in RADIO WORLD of May 19, 1923.)

The front page showed a class in radio at work at the Great Lakes, Mich., Naval Training Station. At that time the U. S. Navy radio personnel totaled 2,419.

The Improved Grimes Reflex Circuit was explained in detail, with accompanying diagram, by W. S. Thompson, E.E.

The first portable radio set using flashlight batteries attracted much attention and led to hundreds of letters from RADIO WORLD readers.

The new wave assignments issued in Washington brought the total up to 590.

Considerable enthusiasm was shown by C. H. Huntley in an article headed "New Tube Operates from a Flashlight Battery."

A. D. Turnbull recited with pride that a 2-tube set had caught Los Angeles programs in Nova Scotia.

The General Electric Research Laboratory, through its Public Relations Department, asked the radio public "to add to its collection of vacuum tubes in order to illustrate the great advances made in this interesting field."

The American Newspaper Publishers Association, holding its annual convention in New York City, named a committee to report on the question: "Should the publication of radio programs be regarded by daily newspapers as a form of advertising for which a regular charge should be made?" History certainly does repeat itself!

The Bureau of Standards, Washington, D. C. (Station WWV) had transmitted radio signals of standard frequency, the range having been from 500 to 1,000 kilocycles. It was announced that within the following few weeks higher frequencies would be transmitted to include waves to be used by amateurs.

A THOUGHT FOR THE WEEK

RADIO DEALERS ALL OVER THE COUNTRY report a big demand for auto sets. A trade paper announced some months ago that there probably would not be much call this year for sets of this type. Somebody must be wrong. We prefer to believe the dealers.

Two for the price of One

Get, EXTRA, one-year subscription for any One of these magazines:

- POPULAR SCIENCE MONTHLY.
- RADIO-CRAFT (monthly, 12 issues).
- RADIO INDEX (monthly, 12 issues), stations, programs, etc.
- RADIO (monthly, 12 issues; exclusively trade magazine).
- EVERYDAY SCIENCE AND MECHANICS (monthly).
- RADIO LOG AND LORE. Bi-monthly; 5 issues. Full station lists, cross indexed, etc.
- AMERICAN BOY-YOUTH'S COMPANION (monthly, 12 issues; popular magazine).
- BOYS' LIFE (monthly, 12 issues; popular magazine).
- OPEN ROAD FOR BOYS (monthly, 12 issues).

Select any one of these magazines and get it free for an entire year by sending in a year's subscription for RADIO WORLD at the regular price, \$6.00. Cash in now on this opportunity to get RADIO WORLD WEEKLY, 52 weeks at the standard price for such subscription, plus a full year's subscription for any ONE of the other enumerated magazines FREE. Put a cross in the square next to the magazine of your choice, in the above list, fill out the coupon below, and mail \$6 check, money order or stamps to RADIO WORLD, 145 West 45th Street, New York, N. Y. (Add \$1.50, making \$7.50 in all, for extra foreign or Canadian postage for both publications.)

Your Name.....

Your Street Address.....

City State

- If renewing an existing or expiring subscription for RADIO WORLD, please put a cross in square at beginning of this sentence.
- If renewing an existing or expiring subscription for other magazines, please put a cross in square at the beginning of this sentence.

RADIO WORLD, 145 West 45th Street, New York. (Just East of Broadway)

**DOUBLE
VALUE!**

Heterodyne Oscillator

(Continued from page 15)

the beat oscillator is a differential device, and the accuracy will depend on the difference, not to the original frequency.

The smaller inductance would require 20 turns of No. 18 enamel wire. These coils are shielded, too. No coil is inductively coupled to the other, that is, the mutual coupling should be zero.

Calibration Pointers

When the heterodyne oscillator is finished, that part of it that duplicates the broadcast band as to frequency coverage may be calibrated against known frequencies of broadcasting stations. Practically all stations stick close enough to their assigned frequencies to be dependable for this purpose.

It will be found that when the heterodyne oscillator is going, and is coupled to the receiver, that the early differences in frequencies will be too low to register, for want of coupling, as they are in the audio realm, but that soon the radio frequency region of 20,000 cycles (20 kc) is reached, and quickly enough, 540 kc, or other extreme low frequency of the receiver. It is well indeed to have an accurately calibrated receiver, as that makes calibration of the heterodyne oscillator all the easier.

The high frequency limit may be just outside the broadcast band, and around 2,000 kc is suggested, as that takes care of the highest frequency of oscillation in broadcast superheterodynes, and the stopping point may be established by adjustment or selection of the maximum condenser capacity. Assuming that the gang condenser is around 50 mmfd., there would be more than enough capacity. However, duals of such small ca-

capacity are not generally obtainable, and the actual or net capacity may be effected by putting adjustable condensers in series with the separate sections of the gang. Thus, the type of air-dielectric condenser used in superheterodyne intermediate transformers may be used. The object is to utilize as much as possible of the condenser dial span to represent the frequencies in the band, otherwise readings would be too crowded.

Condenser Cut Down

When it comes to the audio frequencies themselves, or small differences in frequencies between the fixed and the variable oscillators, it is necessary to have a very tiny dual condenser, and the constructor is left to his own resources to provide this. A separate dial is needed for audio frequencies. If one has an old dual condenser of the junior or midjet type, he may remove all plates except rotor plates except one, and then remove all stator plates except two, one of which would be about half an inch from the rotor, and the other likewise distant. If this capacity proves too high, as it is almost bound to, corresponding stator plates would be removed, until there is only one in each section. Even this would crowd the audio frequencies somewhat. The source

of calibration may be the 60-cycle line hum, introduced in a separate speaker, while one listens to the test oscillator with earphones or speaker. Harmonics will register audio beats.

If a large scale dial is used, and particularly if the reduction ratio is greater than the 4-to-1 or 5-to-1 usually met, the calibration will be spread out greater, which is to the same effect as slower change of capacity in the tuned circuit.

DICTIONARIES—STANDARD ENGLISH

3 LETTER WORDS

or 4 LETTER WORDS, 25c. both
35c. Definition Stand. Eng. Words
25c. Lists of words winning first
prize in recent Gold-Medal, Princess Pat, Path-
finder, Bisquick, Magnesia or Wheaties Contest,
@ 50c. 3 for \$1.00. List first-prize winners in
30 Contests. 25c. Copy of Contest Magazine. 25c.
Dept. R.W.
DeLONG AGENCY, Inc., Lafayette, Indiana

DIAMOND PARTS

Tuned Radio Frequency Sets

FIVE-TUBE MODEL

A-C operated circuit, 50-60 cycles, 105-120 volts, using two 58 t-r-f stages, 57 power detector and 47 output, with '80 rectifier. Three gang shielded condenser and shielded coils in a sensitive, selective and pure-tone circuit. Dynamic speaker field coil used as B supply choke. Complete kit of parts, including 8" Rola speaker and all else (except tubes and cabinet). Cat. D5CK @.....\$15.00
Wired model, Cat. D5CW (less cabinet) @.... 17.19

Kit of five Eveready-Raytheon tubes for this circuit. Cat. DST 4.97

FOUNDATION UNIT, consisting of drilled metal subpanel, 13 1/4 x 8 1/2 x 2 1/4"; three-gang Scovill 0.00035 mfd., brass plate, trimmers, full shield; shields for the 58 and 57 tubes; six sockets (one for speaker plug); two 8 mfd. electrolytic condensers; set of three coils. Cat. D5FU..... 6.19
Super Diamond parts in stock.

FOUR-TUBE MODEL

The four-tube model is similar, except that there is one stage of t-r-f, and a two-gang condenser is used. Tubes required, one 58, one 57, one 47 and one '80. Complete kit, including 8" Rola dynamic speaker (less tubes, less cabinet). Cat. D4CK\$13.58

Kit of four Eveready-Raytheon tubes for this circuit. Cat. 4D.TK\$3.89

FOUNDATION UNIT, consisting of drilled metal plated subpanel 13 1/4 x 2 1/2 x 7"; two-gang 0.00035 mfd. SFL condenser; full shield; two shields for 58-57; center-tapped 200-turn honeycomb coil; five sockets (one for speaker plug); two 8 mfd. electrolytics; set of two shielded coils; 20-100 mmfd. Hammarlund equalizer for antenna series condenser. Cat. D4FU\$5.48

INDIVIDUAL PARTS

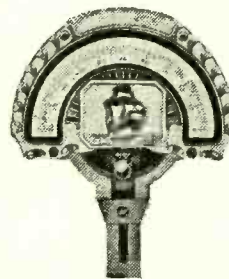

Travelling light vernier dial, full-vision, 6-to-1 vernier, projected indication prevents parallax; takes 1/4" or 3/8" shaft; dial, bracket, lamp, escutcheon.

0-100 for 5-tube Diamond, Cat. CRD-0, @ \$0.91.

100-0 for 4-tube Diamond, Cat. CRD-100, @ \$0.91.

[If dial is desired for other circuits state whether condenser

closes to the left or to the right.]

8 mfd. Polymet electrolytic, insulating washers, extra lug. Cat. POLY-8 @.....\$0.40

Three 0.1 mfd. in one shield case, 250 volt d-c rating. Cat. S-31 @..... 23

Rola 8" dynamic for 47 with 1800 ohm field coil tapped @ 300 ohms. Cat. FP @..... 3.85

2 coils for 4-tube. Cat. DP @..... 39

3 coils for 5-tube. Cat. DT @.....1.35

DIRECT RADIO CO.

143 WEST 45th STREET
NEW YORK, N. Y.

PADDING CONDENSERS



Either capacity, 50c

A HIGH-CLASS padding condenser is required for a superheterodyne's oscillator, one that will hold its capacity setting and will not introduce losses in the circuit, for losses create frequency instability. The Hammarlund padding condensers are of single-condenser construction on Isolantite base, with set-screw easily accessible, and non-stripping thread. For 175 kc. intermediate frequency use the 850-1350 mmfd. model. For i-f. from 460 to 365 kc., use the 350-450 mmfd.

0.0005 HAMMARLUND S. F. L. at 98c.

A sturdy, precision straight frequency line condenser, no end stops. The removable shaft protrudes front and rear and permits ganging with coupling device, also use of clockwise or anti-clockwise dials, or two either side of drum dial. Front panel and chassis-top mounting facilities. True straight line. This rugged condenser has Hammarlund's high quality workmanship and is suitable for precision work. It is a most excellent condenser for calibrated radio frequency test oscillators, any frequency region, 100 to 60,000 kc., short-wave converters and adapters and TRF or Superheterodyne broadcast receivers. Lowest loss construction, rigidity; Hammarlund's perfection throughout.

Order Cat. H05 @.....98c net

Guaranty Radio Goods Co., 143 West 45th Street, New York, N. Y.

Matched Combination of Dial, Condenser, Coil



Dial obtainable with either of two numerically divided scales or with frequency scale.

Travelling light dial, bulb, escutcheon, 6-to-1 vernier, smooth action. Hub is for 3/8-inch shaft but 1/4-inch reducing bushing is supplied. This dial is obtainable with either type numerical scale (100-0 is illustrated) or with frequency-calibrated scale, marked 500 to 150. The frequency scale requires 0.00037 mfd. condenser and 250 microhenries inductance for the broadcast band, or 0.00037 mfd. condenser and 20 millihenries inductance for actual 500 to 150 kc. fundamentals.

Cat. DJAD-0-100 for condensers that increase in capacity when turned to the right. Scale, 0-100..... 75c

Cat. DJAD-100-0 for condensers that increase in capacity when turned to the left. Scale 100-0 75c

Cat. DJADF — Frequency calibrated 94c

Cat. MFCH — (TW) — Honeycomb coil of 20 millihenries inductance. Two extreme lugs for total windings. Con- 45c

Cat. TRF-250 — Radio frequency transformer 2 1/2-inch diameter shield; primary and tapped secondary. Tap may be used for oscillation in cathode leg of 45c

Cat. DJA-14-D — Two gang 0.00014 mfd. short-wave condenser with com- \$1.96 pensators

Cat. DJA-37 — Single tuning condenser, short-wave condenser built in: 0.00037 98c

Short-Wave Condenser

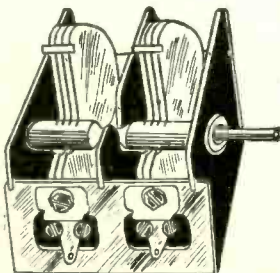

Two-gang condenser for short-waves. Low minimum. Sturdy construction. Ball race at front and back of Shaft. Compensators built in at side. Shaft is 1/4-inch Aluminum plate. Useful with all standard make short-wave coils. 3/8-inch bushing supplied.

DIRECT RADIO CO., 143 West 45th Street, NEW YORK, N. Y.

SHORT WAVES

14
to
200
Meters

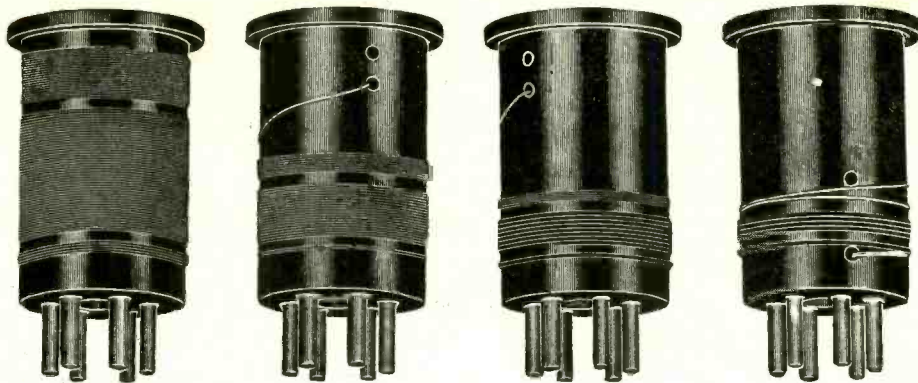

Use
0.00014
Mfd.
Capacity

SIX-PRONG PLUG-IN COILS FOR DETECTOR STAGE

P LUG-IN COILS with six-prong bases that fit into six-pin tube sockets (used as coil receptacles) provide three separate windings: primary, secondary and tickler. The three-circuit coil is most efficient in detector sockets.

Either of the two following uses applies:

- (1)—As detector input from a tuned radio frequency stage, with primary in the plate circuit of a screen grid tube;
- (2)—As detector alone, where there is no r-f. amplification ahead of the detector, primary in the antenna-ground circuit.

See coil connections illustrated below.

The form diameter is 1.25 inch, with gripping flange.

T H E S E coils have proved their effectiveness in many circuits and lend themselves to all types of circuits save those with moving-coil ticklers.

The coils are designed for use with 0.00014 mfd. tuning capacity to tune from 200 meters to below 14 meters. The higher frequency coils have secondaries wound with very thick wire.

The bakelite coil forms are seasoned so that the inductance will not be affected by moisture-content of the forms.

The base pins are strong and durable and the coils will last for several years.

Four coils sent free with 6 months subscription (26 weeks) @ \$3.00. Order Cat. PRE-SWBP.

FOUR-PRONG PLUG-IN COILS FOR ANTENNA STAGE

When a short-wave tuned radio frequency set is built with a stage of t-r-f, the antenna coil should be of the four-pin, two-winding type. Centers of cores should be 6 inches apart or more to prevent back-coupling. No shielding should be used in either case. Coupling between coils makes a circuit tricky to tune. Shields reduce sensitivity too much in t-r-f short-wave circuits. The four-pin coils are wound with secondaries for 0.00014 mfd. and these match the secondaries of the six-pin coils.

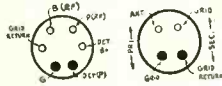

The diagram at left shows connections to make to the sockets of both the UX (four-pin) and six-pin coils. The bottom views of socket connections are shown. The primary of the UX coil connects to Ant. and ground (Grnd.). Follow these connections carefully. If oscillation fails when desired, reverse connections of the secondary (transpose grid and grid return.)

Four UX wound coils sent free with 6 mos. subscription @ \$3. Order Cat. PRE-SWAP.

COIL FORMS



Those who desire to wind their own plug-in coils may use the same forms that prevail in the factory-wound coils detailed above. These coil forms are obtainable in three types. A set of coils of any type consists of four forms.

Any set of four coil forms (not wound) will be sent free for an eight-weeks trial subscription at the regular price, \$1.00.

UX forms (four) order Cat. PRE-CFUX.

UY forms (four) order Cat. PRE-CFUY.

Six-pin (four) order Cat. PRE-CFSX.

TUNING METER

Some short-wave enthusiasts like to tune in stations by the meter method. Thereby they can watch the meter needle for greatest deflection to ascertain resonance. A sensitive milliammeter serves the purpose. One of 5 ma full-scale deflection may be connected in series with the plate feed to an r-f, or intermediate tube, or in the common screen lead of several tuner tubes, or in any other circuit where the steady value of current does not exceed 2 or 3 milliamperes. In all tuner amplifier stages the needle will show higher readings at higher signal levels (modulation is upward) and therefore if only a few milliamperes flow in such circuits the meter may be used. The meter may be used for any d-c current measurement in its range.

The 0.5 milliammeter is of the panel-mount type and is sent free with a six-months subscription (26 weeks) at the regular price of \$3. Order Cat. PRE-TUM.

MICROPHONE

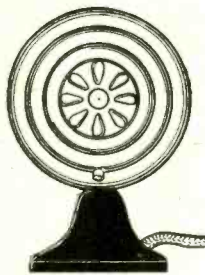

A general utility microphone for home use, that enables you to use the audio amplifier in your receiver and "broadcast" in your home. This microphone is of the high-resistance single-button type, and is useful not only for serious work but also for playing pranks. No battery required. With the microphone are supplied socket templates and directions for connections to detector tubes of various types of receivers. Good results are enjoyably obtained. The microphone will be sent free on receipt of \$2.00 for sixteen-weeks subscription (16 issues), the regular price. Order Cat. PRE-MK.

CONDENSERS

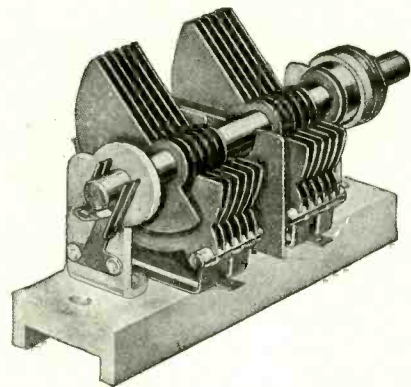

The Hammarlund junior midline short-wave condensers, 0.00014 mfd. work exceedingly well with the coils offered above, but also may be used to advantage in any short-wave set, with any other coils intended for that capacity. These condensers have Isolantite bases, thus enhancing the low-loss construction that prevails throughout.

The condensers illustrated are the single 0.00014 mfd. and the dual 0.00014 mfd. The shafts are 1/8 inch. A vernier dial should be used. See vernier dial offers, for a-c and battery sets, on another page.

Single condenser sent free with three months subscription, (13 weeks) at regular price of \$1.50. Order Cat. PRE-H14. PRE-S-14.

Double condenser sent free with six months subscription (26 weeks) at regular price of \$3.00. Order Cat. PRE-DU-14.

Manual trimmer (40 mmfd.), free with trial subscription, 8 weeks, \$1.00. Order Cat. PRE-MNT.

RADIO WORLD, 145 West 45th Street, New York, N. Y.
(WE PAY POSTAGE ON ALL PRODUCTS LISTED ON THIS PAGE)

YOU CAN NOW BUILD YOUR OWN
Full-Wave Automatic

POSTAL AUTO ELIMINATOR

- **LATEST** List Price \$17.00
- **MODEL** Special \$7.95
- **AVAILABLE** \$7.95
- **MAY 15th** Complete Kit

Furnishes 180 volts at 40 mills drain. Only 1 3/4 Amperes. Operates any Auto or Home set. Operates from 6, 12 and 32 volt battery. Complete and simple instructions for wiring.

SPECIAL OFFER: Complete Kit.....\$7.95
Mercury Vapor Rectifier.....1.36
Wired Eliminator, Complete with chassis, case and tube.....\$11.80

3 in 1 AC-DC Battery

UNIVERSAL RECEIVER

With Dynamic Speaker and 2Z5Z Tube

List Price \$25.00
Special \$9.75
Complete Kit

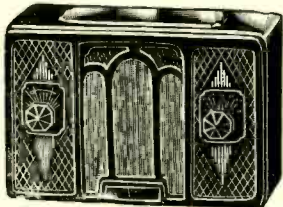

May be operated from any power source (AC—all voltages and frequencies; DC—Delco or Battery systems). Works Everywhere—Automobiles—Motor Boats—Offices. Complete Kit and Instructions, pictorial diagrams, \$9.75. Matched set of R. C. A. or Eveready tubes, \$3.25. Complete receiver custom-built, wired, and tested, with cabinet, carrying case, and tubes, ready to operate.....\$12.90

POSTAL RADIO CORP.

135 LIBERTY STREET, NEW YORK CITY

TROUBLE SHOOTER'S MANUAL, Nos. I and II

Having assembled 2,000 diagrams of commercial receivers, power amplifiers, converters, etc., in 1,200 pages of Volume No. 1 of his Perpetual Trouble Shooter's Manual, John F. Rider, noted radio engineer, has prepared Volume No. 2 on an even more detailed scale, covering all the latest receivers. Volume No. 2 does not duplicate diagrams in Volume No. 1, but contains only new, additional diagrams, and a new all-inclusive information on the circuits covered.

Volume No. 2—Perpetual Trouble Shooter's Manual, by John F. Rider, Shipping weight 6 lbs. Order Cat. RM-VT @.....\$5.00
Volume No. 1 (8 lbs.). Order Cat. RM-VO @ \$5.00

We pay postage in United States on receipt of purchase price with order. Canadian, Mexican and other foreign remittances must be in funds payable in New York.

RADIO WORLD

145 West 45th Street New York City

Quick-Action Classified Advertisements

7c a Word—\$1.00 Minimum
Cash With Order

SELL ELECTRIC NEONLIKE WINDOW DISPLAY SIGNS. Complete, 98c. Particulars. Slogans 8 in. x 14 in. Box 63, Rugby Sta., Brooklyn, N. Y.

SERVICE MEN WHO KNOW THEIR BUSINESS, please write. L. Vidlak, East Hampton, Conn.

URUGUAY STAMPS—100 different stamps, \$1.00. 200 different stamps, \$3.50. Stamps will be shipped direct from Uruguay. Heriberto Meyer, care Radio World, 145 West 45th St., New York City.

BEAUTIFULLY mounted 5 x 7 enlargement. Send 10c with negative. J. Braff, 1475-W, Grand Concourse, New York, N. Y.

NEW RADIO AMATEUR'S HANDBOOK, 180,000 words, 207 illustrations, 218 pages (10th edition, issued 1933). Price, \$1.00 per copy. Radio World, 145 West 45th Street, New York, N. Y.

BARGAINS IN FINEST PARTS! — Highest grade, new parts, few of each on hand. National dial, flat type, modernistic escutcheon, type G, clockwise, \$2.19; Pilot drum dial No. 1235 @ \$1.89; a-c toggle switch, 19c; triple pole, four-throw Best switch, insulated shaft, \$1.62; double pole, four throw, \$1.08. Direct Radio Co., 145 West 45th St., N. Y. City.

"THE CHEVROLET SIX CAR AND TRUCK" (Construction—Operation—Repair) by Victor W. Pagé, author of "Modern Gasoline Automobile," "Ford Model A Car and AA Truck," etc., etc. 450 pages, price \$2.00. Radio World, 145 W. 45th St., N. Y. City.

BLUEPRINT

627. Five-tube tuned radio frequency. A-C operated; covers 200 to 550 meters (broadcast band), with optional additional coverage from 80 to 204 meters, for police calls, television, airplane, amateurs, etc. Variable mu and pentode tubes. Order BP-627 @.....25c

RADIO WORLD

145 WEST 45th ST., NEW YORK, N. Y.

LOOK AT YOUR WRAPPER

You will see by the date thereon when your subscription for Radio World expires. If the subscription is about to run out, please send us renewal so that you will not miss any copies. Subscription Department, RADIO WORLD, 145 West 45th St., N. Y. City.

DUAL-RANGE SWITCHES

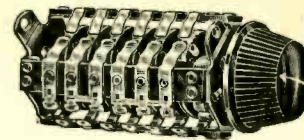

Wiping contact switches that improve with use and have an exceedingly low contact resistance enhance performance in the police-television-amateur bands without disturbing the line-up of the broadcast band.

The switches are sturdy, compact, smooth and dependable. The frame is insulated from the switch connections, so the switch may be used to slide condenser stator from one extreme of coil to a tap on the coil, or to short out part of the coil without changing condenser stator connection. The mounting hole is to be 5/16 inch diameter, with 3/32 hole 1/4 inch away, to engage a small flange that prevents slippage. Two extra holes on a fixed bracket permit additional anchorage to front and possibly rear flaps of chassis.

Type A is for governing three tuned circuits (triple pole, double throw) and besides there is a single pole single throw extra section for shorting and padding condenser or antenna series condenser. Entire switch encompassed by 2-inch diameter. Length, 5 inches; shaft, 1/4 inch, 1" long. Used in 9-Tube Diamond. Cat. EBS-A at \$1.49.

Type B is for governing four tuned circuits and substituting one padding condenser for another (five pole, double throw). The switch is 9 inches long. Used in the 12-Tube Diamond. Cat. EBS-B at \$2.49.

We selected these switches because we deem them the best ones made, in the stated price range, and because they make excellent and definite contact and afford long service. The illustration reveals the general type of construction.

Guaranty Radio Goods Co.

143 West 45th Street New York, N. Y.

115 DIAGRAMS FREE

115 Circuit Diagrams of Commercial Receivers and Power Supplies supplementing the diagrams in John F. Rider's "Trouble Shooter's Manual." These schematic diagrams of factory-made receivers, giving the manufacturer's name and model number on each diagram, include the MOST IMPORTANT SCREEN GRID RECEIVERS.

The 115 diagrams, each in black and white, on sheets 8 1/2 x 11 inches, punched with three standard holes for loose-leaf binding, constitute a supplement that must be obtained by all possessors of "Trouble Shooter's Manual," to make the manual complete.

Circuits include Bosch 54 D. C. screen grid; Balkite Model F Crosley 20, 21, 22 screen grid; Eveready series 58 screen grid; Eria 224 A. C. screen grid; Peerless Electrostatic series; Philco 76 screen grid.

Subscribe for Radio World for 3 months at the regular subscription rate of \$1.50, and have these diagrams delivered to you FREE!

Present subscribers may take advantage of this offer. Please put a cross here to expedite extending your expiration date.

Radio World, 145 West 45th St., New York, N. Y.

NEW MODEL SHIELDED TEST OSCILLATOR!

AN improved modulated test oscillator, fundamental frequencies, 50 to 150 kc, enabling lining up of intermediate frequency amplifiers, i-r-t, and oscillator circuits, is now ready. It is shielded in a metal box 9 1/2" wide x 8 1/2" deep x 4 1/2" high, with beautiful Japanese finish. The test oscillator is obtainable in two models, one for a-c operation, the other for battery operation. The same cabinet is used for both.

The a-c model not only is shielded but has the line blocked, that is, radio frequencies generated by the oscillator cannot be communicated to the tested set by way of the a-c line. This is a necessary counterpart to shielding, and a special circuit had to be devised to solve the problem.

The modulation in the a-c model is the a-c line frequency, 50 cycles, effected by using the line voltage on the plate of the tube. Besides a fuse there is a very high resistance between the shield cabinet and the a-c, a double preventive of line-shorting and application of a-c line voltage to the user.

The oscillator is equipped with an output post. No ground connection need be used, as the circuit is sufficiently grounded through the power transformer capacity to prevent body capacity effects in tuning.

The frequencies are more accurately read than normal use requires, being never more than 2% off, and usually not more than 1% off, many readings being right on the dot (no discernible difference). The frequency stability is of a high order from 100 to 50 kc, and somewhat less from 100 to 150 kc. Zero beats are guaranteed at all frequencies.

The oscillator was designed by Herman Bernard and is manufactured under the supervision of graduates of the Massachusetts Institute of Technology.

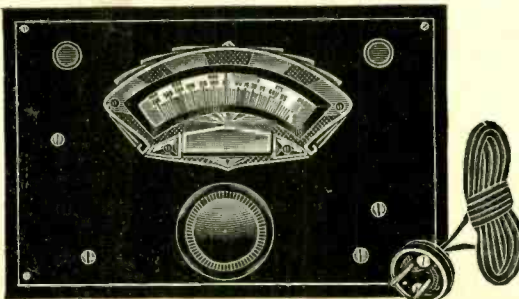

The test oscillator has a frequency-calibrated dial, 150 to 50 kc, with 1 kc separation between 50 and 80 kc and 2 kc separation between 80 and 150 kc. Intermediate frequencies are imprinted on the upper tier. Broadcast frequencies are obtainable on tenth harmonics (500 to 1,500 kc).

GUARANTY RADIO GOODS CO.

143 West 45th Street, New York, N. Y.

THE a-c model is completely self-operated and requires a 56 tube. The battery model requires external 22.5-volt small B battery and 1.5-volt dry cell, besides a 230 tube. The use of 1.5 volts instead of 2 volts on the filament increases the plate impedance and the operating stability. The battery model is modulated by a high-pitched note. Zero beats are not obtainable with the battery model.

A-C MODEL, Cat. SHO-AC, less 56 tube...\$7.88
56 tube 76c extra.

BATTERY MODEL, Cat. SHO-B, less 230 tube, less batteries.....\$7.08
230 tube 98c extra.

Directions for Use

Remove the four screws and the slip cover, insert the 56 tube in its socket, restore the cover and screws, connect the a-c attachment plug to the wall socket, and the a-c test oscillator is ready for service.

For testing some particular set, follow the directions given by the designer or manufacturer. In the absence of such directions, use the following method.

Mentally affix a cipher to the registered frequencies on the lower tier (so 50 is read as 500, and 150 as 1,500), and set the dial for any desired broadcast frequency. Connect a wire from output post of test oscillator to antenna post of set. Leave aerial on for zero beats, off otherwise. At resonance the hum will be heard. Off resonance it will not be heard. For testing intermediate frequencies, connect the wire to plate of the first detector socket. The first detector tube may be left in place and bared wire pushed into the plate spring. The intermediates then are tuned for strongest hum response. If an output meter is used, tune for greatest needle deflection.

The battery model is connected to voltage sources as marked on oscillator outlets and is used the same way.